

C O N T R O L E



The safety of transport of radioactive materials

International regulations

P. 8

Transport safety and prevention of malicious acts

P. 20

Organising a complex transport operation

P. 28

Monitoring safety at all the stages in the life of a package

P. 46

Safety of transport in small-scale nuclear activities

P. 70

The French Nuclear Safety Authority (ASN) website,

All the latest news on nuclear safety
and radiation protection

The screenshot displays the ASN website interface. At the top, the ASN logo is on the left, and the header text reads: "ASN | AUTORITÉ DE SÛRETÉ NUCLÉAIRE. The French Safety Authority (ASN) is tasked, on behalf of the State, with regulating nuclear safety in order to protect workers, patients, the public and the environment in France. It also contributes to informing the public." A search bar is located on the right. Below the header is a navigation menu with links: ABOUT ASN, COMPLEMENTARY SAFETY ASSESSMENTS, EPR REACTOR, NEWS RELEASES, TECHNICAL SUPPORT, REFERENCES, EVENTS, and ASN'S PUBLICATIONS.

The main content area is divided into several sections:

- News releases:** Features a large image of a worker in a hard hat and safety vest. Below it, a headline reads "ASN reports on controls imposed on nuclear reactors' vessels". The text states: "ASN reports on controls imposed on nuclear reactors' vessels in France. In France, ASN controls manufacturing and in service inspection of key operating pressure equipments of nuclear reactors, including the reactor pressure vessel. A specific monitoring of these equipments' construction has been applied since 1974. For all components of French reactors' vessels, a number of controls aiming at detecting defects in forged pieces were carried out during production." A "Read more" link is provided.
- Information on Fessenheim NPP event:** A sub-section with a date of 09/08/2012 9:13. The text reports: "On 5th September 2012, the French Nuclear Safety Authority (ASN) was notified by EDF of an incident related to a gas release which occurred at around 15:00 in nuclear auxiliary buildings[1] of the Fessenheim NPP. During the handling process of hydrogen peroxide, a non radioactive chemical, some of the product was spilled, leading to a steam release which triggered the fire alarm sensors. As provided..."
- ASN's national action plan for management of the radon risk:** 09/01/2012 10:41.
- Fuel storage pool siphon-breakers:** 06/07/2012 9:37.
- CENTRACO incineration furnace:** 07/17/2012 10:25.
- ASN's 2011 report: "there is a before and an after Fukushima":** 06/26/2012 9:00.

Social media links for Facebook, Google+, and Twitter are located below the news releases.

Video: A section titled "A nuclear accident simulation with a seismic dimension: the example of Cadarache" with an English subtitle. It features a video player showing a simulation of a nuclear accident scenario.

ASN's videos: A section titled "Nuclear Safety and Radiation Protection in France in 2011" with a video player showing a presentation slide.

Recent publications: A section titled "Nuclear safety and radiation protection in France in 2011" with a sub-headline "ASN report on the state of nuclear safety and radiation protection in 2011". It includes a "Contrôle review #194" link.

Direct access: A list of PDF documents for download, including "ASN Organisation Chart (PDF - 225.62 kB)", "ASN institutional brochure (PDF - 801.21 kB)", "ASN Strategic plan (2010-2012) (PDF - 718.82 kB)", "Nuclear Safety Authority's rules of procedure 2006 (PDF - 150.75 kB)", "Nuclear security and transparency (TSN) act (PDF - 301.39 kB)", "'Waste' act (PDF - 323.23 kB)", and "BES and ASN-SFRD Scale (PDF - 382.00 kB)".



www.french-nuclear-safety.fr

Foreword

After 15 years of ASN oversight of radioactive material transport, and more than five years after its change of status, I wanted *Contrôle* to provide some enlightenment on the progress made in this area.

Since 12 June 1997, ASN has been responsible for monitoring the radioactive material transport regulations and overseeing their application. The first years were devoted to bringing the organisation of transport oversight closer to that for the safety of nuclear facilities, with the assistance of the IPSN (Institute of Nuclear Safety and Protection), which in 2002 became the IRSN (Institute for Radiation Protection and Nuclear Safety). A regional transport inspection system was set up, with the training of inspectors in the regional divisions of ASN. The INES significant events classification scale, initially devised for nuclear facilities, was extended to transport. The close cooperation with the IRSN was enhanced in 1998 by the setting up of an Advisory Committee of Experts in the transport of radioactive materials (GPT), which now meets two or three times a year at the request of ASN.

ASN now plays an active role with the International Atomic Energy Agency (IAEA) in the development of regulations, and cooperates regularly with its foreign counterparts. Lastly, transparency has become established in the other domains, with the systematic publication of the inspection follow-up letters on the web site www.asn.fr, and the development of initiatives aimed at the public, elected officials and the media, particularly for transport operations that attract high media exposure.

An initial assessment was drawn up in 2004, when the IAEA conducted the TRANSAS audit mission. A second audit organised two years later confirmed that ASN had implemented the recommendations and suggestions resulting from the first audit.

The TSN Act voted in 2006, which is now integrated in the Environment Code, provided a more robust legal framework for ASN's action. Today, nearly six years after its adoption, I consider that the provisions of this act have



been implemented. The credibility of the ASN's regulatory role has been considerably enhanced by the fact that since 2006, ASN and its inspectors can impose sanctions. The adoption of an order on the technical regulation of basic nuclear installations (BNI) in February 2012 is a major step in the renovation of the regulatory pyramid which will be completed with the publication of some fifteen ASN resolutions in the coming months. These technical regulations provide more specifically for a tightening of the requirements relating to the safety of transport within the BNIs.

This issue of *Contrôle*, over and beyond the abovementioned progress, aims to identify prospective actions for the coming years, both nationally and internationally.

Jean-Christophe NIEL
ASN Director-General

* TRANSAS : TRANsport Safety Appraisal Service.

The safety of transport of radioactive materials

The recent transport of vitrified waste between France and Germany has shown the extent to which the transport of radioactive materials can raise questions on the part of the public and associations. The right of access to information held by public entities is a fundamental human right enshrined in article 19 of the Universal Declaration of Human Rights of the United Nations, which guarantees the right to "seek, receive and impart information and ideas". It is at the core of the "TSN Act" relating to transparency and security in the nuclear field, the first to introduce the term "transparency" into French legislation. Meeting this objective of transparency is one of ASN's duties, which implies taking into consideration the viewpoints of the stakeholders, the public and the media. *Contrôle* exists to contribute to this transparency.

Transparency requires the information to be understandable to everyone. It was thus decided to adopt the principle of alternating interviews with leading articles to improve the understanding of each subject.

A second decision was to present contributions from all the transport stakeholders in order to show just how varied it is, and to let each sector express its opinion. *Contrôle* thus gives voice to ASN inspectors, to professionals and industrialists - whether from the nuclear industry or not, to experts, to foreign counterparts of ASN, to other administrations, and to two environmental protection associations.

Lastly, the editorial staff wished, in the context of this review, to address a question that is rarely raised because of its sensitivity in the field of transport, namely to find a balance between the objective of transparency and the vital need for secrecy to protect transport operations against malicious acts and, in certain cases, to maintain public order. Several contributors express views on this subject, thus fuelling the debate on a subject that is delicate for the public authorities.

We hope that this issue will meet the expectations of the public and raise constructive questions that will help transport safety progress. We wish you excellent reading!

Laurent KUENY
Coordinator of *Contrôle* 193

Find *Contrôle* on www.asn.fr

How use the flashcode :

- 1 - Use your smartphone to download the free Mobiletag app on Appstore, Android market or Nokia Ovi.
- 2 - Open the Mobiletag app and point at the above flashcode.
- 3 - View the review *Contrôle*.



summary

Overview of radioactive material transport 4

By Laurent Kueny, Director of Transport and Sources - Nuclear Safety Authority (ASN)

International regulations applied by a national Authority

Working towards mutualisation of the work of the European nuclear safety authorities in the area of transport package certification 8

Interview with André-Claude Lacoste, Chairman of ASN

EACA European Association of Competent Authorities on the transport of radioactive material 11

By Stephen Whittingham, Chairman

The European Commission's project to regulate carriers in Europe 13

Interview with Joël Binet, Senior Assistant, General Directorate for Energy - European Commission

Role of the TRANSSC committee 14

By Jim Stewart, Head of Transport Security Department - IAEA

The need for international harmonisation of practices: experience feedback on the transport of uranium hexafluoride packages in UX-30 overpacks 16

By Colette Clémenté, Assistant to the Director of Transport and Sources - Nuclear Safety Authority (ASN)

Transport safety and prevention of malicious acts: creating a synergy

Protecting shipments against malicious acts 20

By Colonel Christian Riach, Head of the Nuclear Security Department in the Ministry of Ecology, Sustainable Development, Transport and Housing (MEDDTL)

Synergies between security and safety: lessons learned from the international conference of the IAEA 21

By Denis Flory, Deputy Director General, Head of the Nuclear Safety and Security Department - IAEA

The role of the IRSN's transport operations section in the field of security 24

By Olivier Loiseau, Head of the Office of Transport Security and Support for the Protection of the Facilities of the Defence, Security and Non-proliferation Unit, and Frédéric Mermaz, Head of the Technical Support and Studies Service of the Defence, Security and Non-proliferation Unit - Institute of Radiation Protection and Nuclear Safety (IRSN)

Transparency and secrecy in the area of nuclear material transport 25

By General Laurent Demolins, Deputy Defence and Security High Official, Head of the Defence, Security and Economic Intelligence Service

Organising a complex transport operation while guaranteeing safety and transparency: the example of the return of vitrified waste to Germany

The pre-departure inspections of the Franco-German convoy 28
By Julie Krochmaluk, Inspector, Transport and Sources Department – The Nuclear Safety Authority (ASN)

The supervision of radioactive material shipments: an extensive approach to the safety of transport operations 31
By Marc Lebrun, Transport Supervision Director – AREVA

The ASN system for informing the public about the transport of radioactive materials 34
Interview with Alain Delmestre, ASN Deputy Director-General and Director of Communication and Public Information

ASN calls upon ACRO's expertise for the convoy of vitrified waste packages shipped to Germany 37
Interview with Pierre Barbey, Vice-Chairman of Association for the Control of Radioactivity in West France (ACRO)

Participation of the STOP-EPR group at ASN's inspection of the convoy of vitrified waste packages shipped to Germany 38
Interview with representatives of the "STOP EPR, ni à Penly ni ailleurs" group

Security and safety: values that the SNCF Group shares 40
By Vanessa Bonvalot, expert in asbestos, chemical risks and ionising radiation in the Human Resources Department of SNCF, Didier Belleville, Transport Safety Advisor in the SNCF Freight Department, Patrice Rollinger, STSI Operations Director, SNCF Géodis Group

The transport of radioactive material between France and Germany over the last 40 years 44
By Ulrich Alter, Federal Minister of the Environment, of Nature Protection and of Nuclear Safety - Germany

Monitoring safety at all the stages in the life of a package

Study of the risks associated with the extreme situations that can arise during the transport of radioactive materials 46
By Gilles Sert, Assistant to the Safety Appraisal Director, Institute for Radiation Protection and Nuclear Safety (IRSN)

A necessary diversification of expertise: the role of the Advisory Committee of Experts for Transport 49
Interview with Jacques Aguilar, Chairman of the Advisory Committee of Experts for Transport

Moving towards a new consensus on the reference methods and parameters to use in the approvals of transport package designs 52
By Colette Clémenté, Assistant to the Director of Transport and Sources – Nuclear Safety Authority (ASN)

The inspection of package manufacture by ASN 54
By Claire Sauron, Inspector, Transport and Sources Department – Nuclear Safety Authority (ASN)

Contrôle 193 : The safety of transport of radioactive materials



Designing and producing a package for the transport of radioactive materials 56
By Fabien Labergri, Technical Director – ROBATEL Industries

On-site transport movements in secret basic nuclear installations 59
By Emmanuel Jacob, Special Advisor – Defence Nuclear Safety Authority (ASND)

On-site transport operations on the nuclear sites 61
By Claire Sauron, Inspector, Transport and Sources Department – Nuclear Safety Authority (ASN)

Co-operation between UK and French Competent Authorities on the Regulation of the Safe Transport of Radioactive Materials 62
By George Sallit, deputy chief inspector, Radioactive Material Transport Department – Office for Nuclear Regulation (ONR), Grande-Bretagne

Inspections and sanctions in Belgium 63
By Guy Lourtie, Head of the Import & Transport Department – AFCN (Federal Agency for Nuclear Control), Belgium

The specific aspects of emergency organisation in the event of a transport accident 66
By Elisabeth Dupin, Inspector, Environment and Emergency Situations Department – Nuclear Safety Authority (ASN)

Safety of transport in small-scale nuclear activities

Very short-lived radionuclides in medicine: the transport challenge 70
By Guy Turquet de Beauregard, Executive Vice-President – IBA Molecular Europe, Saclay

The role of the small-scale nuclear activities transport safety advisor 72
Interview with Jean-Marie Eymat, Transport Safety Advisor – Sécuritrans

Experience feedback from inspections and raising awareness among the small-scale nuclear activity players 74
Interview with Jean-Christophe Luc, Radiation Protection and Radioactive Material Transport Inspector, Bordeaux Division of ASN

Overview of radioactive material transport

By Laurent Kueny, Director of Transport and Sources – Nuclear Safety Authority (ASN)

Fifteen million dangerous goods packages are transported each year in France, and about 900,000 of these packages contain radioactive materials. The latter therefore represent a small proportion of the total number of dangerous goods packages transported. The modes of transport used are road, rail, air, sea, and inland waterways. A little more than 600,000 shipments (i.e. transport movements) are made per year.

The shipments relating to the nuclear power industry, which attract the greatest media interest, represent about 15% of the annual radioactive material transport movements, while 85% of the transported packages are intended for the health, non-nuclear industries or research sectors, referred to as small-scale nuclear activities, of which about 30% is accounted for by the medical sector alone.

It is estimated that about 11,000 shipments per year are required for the fuel cycle of the nuclear power plants (NPP), whether considering fresh uranium-based fuel (about 300 shipments), MOX fuel (about thirty shipments per year), spent fuel from the NPPs and destined for the La Hague reprocessing plants (about 200 per year, of which ten or so come from abroad), or the shipments of uranium hexafluoride and plutonium oxide. Around one thousand shipments (representing about 50,000 packages) to or from foreign countries take place each year.

These shipments are the subject of increasing attention from the public and the media. Consequently, ASN has made it a priority to develop the information available to the public concerning the regulating of the safety of transport of radioactive materials. An educational file accompanied by videos was posted on the ASN web site at the end of 2011.

The shipments that attract the most attention are unquestionably the convoys of spent fuel from the nuclear power industry coming into France from abroad, and the return of the waste resulting from its reprocessing to the country of origin, as was the case in November 2011 when the last convoy of vitrified waste returned to Germany.

For nearly 40 years now, AREVA - on its La Hague site - has been reprocessing spent nuclear fuel from water reactors belonging to foreign electricity companies or research institutes, in the framework of intergovernmental agreements. The countries that have ongoing exchanges with France at present are Germany, the Netherlands, Japan, Belgium, Switzerland, Australia and Italy.



The principles of safety in the transport of radioactive materials

The major risks involved in the transport of radioactive materials are:

- the risk of inhalation or ingestion of radioactive particles in the event of release of radioactive materials;
- the risk of external irradiation of persons in the event of damage to the “biological protection” of the packages, a technical material that reduces the radiation received through contact with the package;
- contamination of the environment in the event of radioactive material release;
- the starting of an uncontrolled nuclear chain reaction (“criticality safety” risk) that can cause serious irradiation of persons if water is present and the safety of fissile radioactive materials is not controlled.

Moreover, radioactive materials can also be toxic and corrosive. This is the case for example with shipments of natural uranium, which has low radioactivity therefore the major risk for man is the toxic risk in the event of ingestion. Similarly, uranium hexafluoride (UF₆), used in the manufacture of fuels for nuclear power plants can, in the event of release and contact with water, form hydrofluoric acid, a powerful corrosive and decalcifying agent.

Catering for these risks implies having full control over the behaviour of the packages to avoid any release of

on asn.fr

■ Special report
on the transport
of radioactive
materials





Arrival of a truck at the logistics building of the VLL Waste Repository in the Aube département¹

material and deterioration in the package protection in the event of:

- fire;
- physical impact further to a transport accident;
- ingress of water into the packaging (water facilitates chain nuclear reactions in the presence of fissile materials);
- chemical interaction between the various constituents of the package;
- substantial release of heat from the transported materials, to avoid possible heat damage to the package constituent materials.

Like the safety of facilities, the safety of transport is also based on the concept of defence in depth and relies on:

- the package;
- the reliability of the transport operations;
- emergency management in accident situations.

The safety of shipments depends first and foremost on the safety of the package. This approach has resulted in the laying down of the following broad safety principles:

- regulatory tests and safety demonstrations are required by the regulations to prove that the packages can withstand reference accidents;
- the required level, particularly with regard to the reference accidents that the package must withstand, depends on the level of risk presented by the package content.

Types of package defined by the regulations

The degree of safety of the radioactive material packages is adapted to the potential danger of the material transported. There are five broad types of package: excepted packages, industrial packages, type A packages, type B packages and type C packages. These package types are determined according to the characteristics of the transported material, such as the total radiological activity, the specific activity - which corresponds to the level of concentration of the material, its physical-chemical form or the possible presence of fissile radioactive materials that could cause a nuclear chain reaction.

Excepted packages

Excepted packages are used to transport very small quantities of radioactive materials, such as very low level radiopharmaceuticals. These packages are not subject to any qualification tests. They must nevertheless comply with a number of general specifications, notably with regard to radiation protection, to guarantee that the radiation around the excepted packages remains very low.

Industrial packages and non-fissile type A packages

Industrial packages are used to transport material with low radioactivity concentrations. For example, uranium-containing materials extracted from foreign uranium mines are transported in France in industrial drums with a capacity of 200 litres loaded into 20-foot containers or conventional rail wagons.

Type A packages are used to transport radioactive materials with low total activity. Type A packages can, for example, be used to transport medical radioisotopes such as technetium generators, commonly in nuclear medicine departments.

Type B packages and fissile packages

Type B packages allow the transport of large quantities of some of the most dangerous radioactive materials such as spent fuels, vitrified high-activity long-lived nuclear waste and fresh fuels. Given the level of risk associated with these packages, they are subject to an approval delivered by ASN based on the examination of a safety file. Approximately 60,000 type B packages are transported each year in France, essentially for the nuclear industry and industrial technical inspections, including industrial radiology.

Type A packages and industrial packages containing fissile radioactive materials are also subject to ASN approval.

Type C packages

Type C packages are designed for transporting highly radioactive materials by air. In France, no approval exists for type C packages for civil uses.

1. *Département*: Administrative region headed by a Prefect

Type B package: gamma ray projector containing an iridium source



TABLE 1: REQUIRED PERFORMANCE LEVELS BY TYPE OF PACKAGE

PERFORMANCE	ROUTINE	NORMAL	ACCIDENT
Excepted package	yes	-	-
Industrial package	yes	no (IP-1)/yes	-
Type A package	yes	yes	-
Type B package	yes	yes	yes
Fissile package	yes	yes	yes
UF ₆ package	yes	yes	yes

For these packages, the international texts have defined performance standards and three general degrees of severity, with reference tests:

- routine conditions of transport: the package is capable of withstanding the normal vibration and accelerations that could occur in incident-free situations;
 - normal transport conditions: the package is capable of withstanding tests representative of minor mishaps (storm, falling onto surface from a height of 1m20, a bar falling onto the package from a height of 1m, compression force equal to 5 times the maximum weight of the package);
 - accident transport conditions: the package is capable of withstanding tests representative of an accident situation (falling onto an unyielding surface from a height of 9 m, falling onto a vertical steel bar from a height of 1m, fire at 800°C for 30 minutes, immersion at a depth of 15 m for 8 hours);
- Table 1 summarises the performance levels that the different types of package must achieve.

Classification of a package – presentation of the “Q-System”

The regulations define the activity thresholds by radionuclide to determine the package to use to transport the radioactive materials.

These thresholds include the values A1 and A2 that set the threshold beyond which approval of the package used will be required.

Threshold A1 is used for a radioactive material in special form.

Special form radioactive material is:

- either a solid indispersible radioactive material;
- or a sealed capsule containing radioactive material (2.2.7.1.3 of the ADR Directive);

It must moreover have a certificate of approval, like the type B packages.

In all the other cases, the value A2 will be used.

These A1 and A2 activity values are calculated using the “Q-System”. This is a calculation model that takes up five scenarios, two for irradiation (beta rays and photons) and three for contamination (ingestion, inhalation, immersion) such that total destruction of the package would lead to a dose rate of 100 mSv/h at a distance of 1 m from the source.

In the case of special form materials, only the irradiation scenarios are concerned.

Regulation of transport safety

In France, ASN has been responsible for regulating the safety of radioactive material transport for civil purposes since 1997.

On this account, ASN’s duties in the transport domain include:

- checking, from the safety aspect, all the stages in the life of a package, from design and manufacture through to maintenance;
- checking compliance with the safety regulations during the shipment and transportation of the packages.

With the exception of the risk of theft, attacks, sabotage or misappropriation of nuclear material for malicious purposes, for which the French Defence and Security High Officials (HFDS) are the responsible regulatory Authorities, ASN is the competent body for the prevention of accident and health risks associated with the transport of radioactive materials (irradiation, contamination, criticality and chemical risks).

The ASN delivers the certificate of approval to the package designer.

By listing and analysing the various transport incidents, ASN can identify the problems faced by transport operators and the possible safety risks in order to improve current practices and identify any needs for changes in the regulations. Any deviation from the regulations applicable to the transport of radioactive materials must be notified to ASN.

More than half of the events are notified by entities involved in the nuclear cycle. About a third of the events concern radioactive pharmaceutical product shipments. Very few transport-related event notifications are made by the conventional industry and research sectors. This number must however be considered with caution, as it probably reflects shortcomings in events notification by professionals in small-scale nuclear activities, who are sometimes less familiar with the notification process. Indeed, the majority of events notified to ASN are events that cannot be overlooked, such as thefts or losses of packages, or deviations detected during interactions with the nuclear cycle players (transport of a gamma ray projector to a nuclear power plant, for example). The majority of notified events concern road transport. The share of events concerning air transport – about one third in 2011 - essentially concerns package impacts or falls during handling, or temporary or definitive losses in transit. Rail and maritime transport modes are involved in few events.

Nevertheless, the year 2011 was marked by an increase in event notifications associated with deviations in application of the requirements of the approval certificates and of the operating or maintenance manuals. ASN analyses these points in depth and pays particular attention to them in the inspections relating to transport of radioactive materials. ■

Reprocessing spent fuels from foreign sources in the AREVA NC La Hague facilities

Data drawn from the AREVA NC 2010 Report

Contract with Germany

Between 1973 and 2008, 5,483 tonnes of uranium and plutonium from spent fuel were shipped into and reprocessed on the AREVA NC La Hague site. This reprocessing produced about 3,000 standard vitrified waste containers (CSD-V) and 4,100 standard compacted waste containers (CSD-C).

As at 31st December 2010, about 2,700 CSD-V containers had been shipped back to Germany. Consequently there remained about 300 CSD-V and 4 100 CSD-C containers to ship. Shipping of the CSD-V containers was completed in 2011. Shipping of the CSD-C containers will start in 2012.

Contract with Japan

Between 1979 and 1999, 2,944 tonnes of uranium and plutonium from spent fuel were shipped into and reprocessed on the AREVA NC La Hague site. This reprocessing produced about 1,300 CSD-V and 1,800 CSD-C containers.

As at 31st December 2010, all the CSD-V containers had been shipped back to Japan, the last shipment being made in 2007. Consequently, 1,800 CSD-C containers remain, and their shipping is planned as of 2013.

Contract with the Netherlands

Between 1976 and 2005, 326 tonnes of uranium and plutonium from spent fuel were shipped into and reprocessed on the AREVA NC La Hague site. This reprocessing produced about 150 CSD-V and 200 CSD-C containers.

As at 31st December 2010, there were fewer than 10 CSD-V containers and about 120 CSD-C containers stored in La Hague for shipping to the Netherlands.

On 1st July 2010, a new agreement between the French and Dutch governments entered into force. It allows waste to be shipped from the Netherlands to France until 31 December 2020. The last return shipment of reprocessed waste must take place before 31st December 2034.

In 2011, 3 convoys containing CSD-C containers were shipped to the Netherlands, while 2 convoys of spent fuel were received at La Hague.

Contract with Belgium

Between 1978 and 2006, 671 tonnes of uranium and plutonium from spent fuel were shipped into and reprocessed on the AREVA NC La Hague site. As at 31st December 2010, there remained 170 kg to reprocess, and reprocessing should be completed by 31st December 2012. Further spent fuel elements should be delivered in the future, but this requires the prior signing of an intergovernmental agreement.

As at 31st December 2010, the fuel elements already reprocessed had produced about 400 CSD-V and 400 CSD-C containers. All the CSD-V containers and 50 CSD-C containers have already been shipped back to Belgium. Consequently, about 350 CSD-C containers remain to be shipped.

Contract with Switzerland

Between 1975 and 2006, 771 tonnes of uranium and plutonium from spent fuel were shipped into and reprocessed on the AREVA NC La Hague site. As at 31st December 2010, there remained 148 kg to reprocess during 2011.

As at 31st December 2010, the fuel elements already reprocessed had produced about 450 CSD-V and 550 CSD-C containers. About 215 CSD-V containers and 150 CSD-C containers have already been shipped back to Switzerland. Consequently about 225 CSD-C and 400 CSD-C containers remain to be shipped.

Contract with Australia

Between 2000 and 2005, 154 kilogrammes of uranium and plutonium from spent fuel were shipped into and reprocessed on the AREVA NC La Hague site. As at 31st December 2010, there remained 131 kg to reprocess, and this should be completed by 31st December 2012.

As at 31st December 2010, the fuel elements already reprocessed had produced about 15 CSD-V containers. Their shipping is planned as from 2015.

Contract with Spain

The spent fuel shipped in from Spain and reprocessed on the AREVA NC La Hague site produced about 65 CSD-V containers. Their shipping is planned as from 2014.

Contract with Italy

Deliveries of spent fuel from Italy have been in progress since 2007 and should continue until 2015. 235 tonnes of uranium and plutonium should be delivered. As at 31st December 2010, 190 tonnes of spent fuel had been delivered and reprocessed, producing 6 CSD-V containers and 219 CSD-C containers. In 2011, 2 convoys from Italy were received. The return shipping operations will be staggered between 2020 and 2025. ■

TABLE 2

	URANIUM SHIPPED IN	ALREADY SHIPPED BACK ¹		STILL TO BE SHIPPED ¹	
		CSD-C	CSD-V	CSD-C	CSD-V
Germany	5,483	0	2,700	4,100	300
Australia	154	0	0	0	15
Belgium	671 ²	50	400	350	0
Spain	-	0	0	0	65
Italy	235 ³	0	0	219	6
Japan	2,944	0	1,300	1,800	0
Netherland	326 ⁴	120	140	80	10
Switzerland	771	150	215	400	225

1. As at 31st December 2010

2. New incoming shipments planned after signing an intergovernmental agreement

3. At term, in 2015

4. Between 1976 and 2005, shipments having resumed in 2010

Working towards mutualisation

of the work of the European nuclear safety authorities in the area of transport package certification

Interview with André-Claude Lacoste, Chairman of ASN

Contrôle: how would you assess ASN's 15 years of radioactive material transport regulation ?

A.C. Lacoste: ASN effectively took over the regulation of radioactive material transport in 1997. It was a vast undertaking, at both national and international level. In my opinion, three essential factors have emerged from these fifteen years of regulation work.

Firstly, the inspections have been considerably reinforced. During these fifteen years, the ASN inspectors have carried out more than 1,000 inspections in the field of transport and delivered about a thousand package approval certificates, gradually increasing the requirements, without revealing any major safety problems. Their power to sanction has been considerably increased since 2006. The inspectors ensure that all significant events notified in the area of transport - some fifty per year - form the subject of experience feedback.

The second point concerns ASN's international action. This action is essential, because it is at international level that the transport regulations are developed. ASN has gradually established itself as a key player within the Transport Safety Standards Committee (TRANSSEC) of the IAEA in Vienna, making the regulations evolve to ensure enhanced safety. But it above all became aware - along with its European counterparts - that European practices and positions had to be harmonised. This is the prerequisite for increasing the effectiveness of our action and weighing more heavily in the international negotiations in Vienna.

Lastly, transparency is now at the core of our practices. Legislation clearly confers an informative role on ASN.

ASN endeavours to give the public information that is clear, complete and understandable. The follow-up letters to our inspections in the area of transport, as in the other areas, are posted on our web site. We report annually to parliament by presenting our Report on the State of Nuclear Safety and Radiation Protection in France. But this in itself is not enough. The nuclear domain is a highly specialised field that obliges us to develop our modes of action and our communication and information media to meet the growing expectations of our various audiences (professionals, informed public, and general public).

In your opinion, what are the major transport regulation challenges for the next ten years?

Transport safety depends first and foremost on the design of the transport packages, but safety cannot be guaranteed unless just as stringent requirements are placed on package manufacture and maintenance. In the past, a very great effort was devoted to verifying the design of approved packages, notably through in-depth appraisals performed by the IRSN, ASN's technical support organisation. This effort must be maintained, but ASN must step up the inspections of package manufacturing and maintenance activities, which are increasingly performed by foreign subcontractors. This is an important issue that already leads us to regularly conduct inspections in foreign manufacturing or maintenance companies. The packages are generally used for about twenty years, and maintaining them in safe condition is a fundamental part of the system for preventing transport-related risks.

The manufacturing and maintenance inspections must also include the packages that are not subject to ASN approval. This is all the more important given that these packages,



which contain radioactive material with low specific activity, are not subject to design verifications by ASN.

Another area in which we are also stepping up our actions is the transport of radioactive materials within nuclear facilities. These transport operations are not subject to the international transport regulations because they take place on the private property of the nuclear licensees, and not on public highways. The new regulations governing basic nuclear installations plan to change this situation by revising in depth the requirements for these "on-site" transport operations in nuclear facilities. These revised regulations will improve the interface between the requirements relating to transport safety and those relating to nuclear facilities.

Beyond these technical issues, the harmonisation of our transport practices at European and international level remains self-evident: all the nuclear safety Authorities check the safety of packages that cross the frontiers by applying regulations developed at international level.

In that case, should the verification of transport safety not be entrusted to a European entity rather than to national Authorities?

There is a paradox in the area of radioactive material transport in Europe. There are very few package designers in Europe, and they are located essentially in France, the United Kingdom and Germany. The common requirements result from common regulations, whose technical bases are established in Vienna. Yet we, the competent Authorities, continue to examine package approval applications each at our own level, using means and above all practices that sometimes differ greatly from one Authority to another.

Fortunately, some packages are the subject of automatic approval recognition between the countries, but for a good number we are obliged to examine the same files several times. Let me take the example of a package designed in the United States called UX-30, which is widely used across the world for transporting uranium, enriched or not, in the form of uranium hexafluoride (UF_6): all the European countries examined an approval recognition application.

While the other European Authorities recognised the American approval, ASN - having identified some uncertainties and with the backing of the IRSN - requested additional studies, with the result that the approval was not recognised immediately. This situation is unsatisfactory; with this type of file, we should have a single common position in Europe

Moreover, if a package should be found to have a safety deficiency that is serious enough to require suspension of its approval, would it not be logical for the prohibition on use of the package to be automatically applicable throughout the European Union?

We have already made progress in Europe. Bilateral exchanges are increasing. ASN maintains particularly close ties with the Belgian, British and German nuclear Authorities. Along with the British nuclear Authority, ASN contributed to the creation of a club called the European Association of Competent Authorities (EACA) on the transport of radioactive material. This club, which counts 22 competent Authorities from the European Union, has already shown its effectiveness since its creation in 2008. Thanks to its initiatives, in Europe, the safety files - which form the basis of transport package approval applications -



The European Commission is already proposing regulations for the European radioactive material carriers, is it not?

Regulations are effectively being proposed to register all European carriers of radioactive materials in a common European-wide database. The registration requirements proposed by the text are not stringent. The main benefit of this new tool would be to have greater knowledge of the radioactive material carriers in Europe and a means of applying administrative sanctions by suspending registration certificates when necessary. The project still raises a large number of questions as to its applicability, but it would have the merit of facilitating the inspection of radioactive material carriers in all the European countries.■

International conference on safe and secure transport – October 2011

are all drawn up following the same structural template, which facilitates collaboration between the Authorities. Moreover, a joint inspection guide is currently being finalised.

But we must no doubt go further than this. In France we militated for the adoption of a European directive on nuclear safety. Adopted in 2009, this directive constitutes a general framework for nuclear safety in Europe, but transport is not included in its scope. In my opinion this is a gap that must be filled. The standards in the field of transport are already common to Europe, and stem from international regulations. But the peer review¹ obligation could be imposed at European level to verify that the right measures are taken in all the countries of the European Union.

One way forward, more simple to implement, could be greater mutualisation of the European safety Authorities' work for the delivery of transport package approval certificates, based on the model of cooperation that exists between the ASN and the UK Authority. The mutualisation could also concern inspector training and the management of emergency situations further to a transport accident.

1. A peer review involves having a team of members of foreign nuclear safety Authorities examine the safety framework of a given country, check application of the regulations, standards and good international practices, and propose corrective measures if necessary.



EACA European Association of Competent Authorities on the transport of radioactive material

By Stephen Whittingham, Chairman

Background

The IAEA Transport Regulations, which are adopted into the UN Model Regulations, which in turn are adopted in the ADR¹ and RID² Agreements for road and rail transports and the IMDG³ Code and ICAO⁴ Technical Instructions for sea and air modes, were first published in 1961. Since that time the IAEA has revised their requirements several times to reflect experience and the latest advances in knowledge and technology; the latest revision will be published in 2012.

The transport of nuclear material has been successfully and safely undertaken for over 40 years without serious incident yet the transport of nuclear material continues to attract public attention, though it can be said often the public attention is not for reasons of public concern about the safety of transport.

Putting the transport of nuclear material into context, each year in the European Union approximately 3 million packages containing radioactive material are transported by road, rail, sea and air with only approximately 5% related to the nuclear sector. Radioactive material is used in many products and industrial products and of course in the diagnosis and treatment of cancer, consequently a high proportion of packages transported relate to the industrial testing sectors principally by road and the radiopharmaceutical sector by road/air/road which need reliable and fast delivery routes due to the short half-life of the isotopes involved.

Compliance with transport regulations is the single most important factor that affects transport safety. The introduction of more regulatory requirements, particularly variations in requirements in the countries involved in the transport route, does not automatically improve safety; it can sometimes have the opposite effect by making the transport regulations too complex and inconsistent. Over the last decade became increasingly apparent to many involved in the regulatory oversight of the transport of radioactive material, that closer collaboration between competent authorities would provide a more effective basis to harmonise the interpretation of transport regulatory requirements between States who operate under the ADR and RID European Agreements and to share relevant and good practice between the transport regulatory authorities.

Bilateral agreement between France and UK

In 2006 a bilateral agreement between France and the UK Authorities was signed for mutual recognition of packages requiring multilateral approval. The basis for this scope of agreement being that both authorities had previously been reviewed by IAEA TRANSAS⁵ missions and found to meet IAEA requirements. This agreement continues to enable both countries to validate the others approval of a package design originating in their country without further assessment. Importantly, it does not undermine national sovereignty in that it does not restrict either country from carrying out any assessment work on a package design they consider necessary.

The benefits of this relationship are:

- improved understanding of assessment methodologies;
- clarified differences of approach;
- enhanced working relationships between the Authorities;
- increased confidence to discuss issues.

The European Association of Competent Authorities (on the transport of radioactive material)

In 2008, UK and France decided to share the benefits of the experience gained with their bilateral agreements by the creation of an Association which is open to all other European Competent Authorities / transport safety regulators for radioactive material ; and so the European Association of Competent Authorities was created. Membership is voluntary and non-legally binding and is open to all European countries.

The vision of the Association is :

The coordinated approach of the Association will develop a common or harmonised approach for the interpretation of the regulations for the transport of radioactive material in Europe. This will provide a proactive means of maintaining and developing a consistent high level of safety for the transport of radioactive material in Europe.

1. ADR : European Agreement concerning the International Carriage of Dangerous Goods by Road.

2. RID : Regulations concerning the International Carriage of Dangerous Goods by Rail.

3. Code IMDG : International Maritime Dangerous Goods code.

4. ICAO : International Civil Aviation Organisation.

5. TRANSAS : TRANsport Safety Appraisal Service.





The objectives are :

- develop networking between Competent Authorities for transport safety;
- share knowledge and relevant good practices and, potentially, resources;
- identify need and participate in joint working groups with defined outputs;
- develop common understanding and promote more effective interaction between competent authorities at a working level.

Membership to the Association is restricted to competent authorities and transport safety regulators and no industry or industry associations are given observer status – this to promote open discussion between the members in a confidential atmosphere.

The European Association of Competent Authorities (EACA) currently consists of 22 European countries that have participated and contributed to the meetings and work programme of the Association since its formation in 2008. Additional members are foreseen early next year.

Work programme

All activities under the responsibility of competent authorities are possible with work focused on the interpretation of the regulatory requirements and implementation of regulatory oversight / intervention, including:

- Exchange of information
 - Review of State variations;

- Issues and initiatives in European countries;
- Package design assessment issues.

- Development of relevant and good practice guidance for example:
 - Structure and content of Package Design safety Reports;
 - Radiation Protection programme (reduction of doses);
 - Packages not requiring competent authority approval;
 - Compliance inspection programmes for Competent Authorities

- Development of joint action plans (future intention):
 - Joint audits / compliance inspections of dutyholders;
 - Exchange of staff for training.

- Discuss changes to the transport regulations (IAEA, European)

- Development of a website for public access

As an example of topics discussed, during the last meeting in Madrid in May 2011, the issues arising from the monitoring, for radioactive contamination, of goods imported from Japan was discussed. Members of the EACA agreed that a communiqué would be helpful to convey the views of the EACA membership to the European Commission regarding what can be learned from this experience and how this can inform the development of future improvements.

Benefits

The benefits of the Association are for:

Competent Authorities

- improve networking and promotion of common understanding at a working level;
- identify and promote good and appropriate practices;
- improve consistency of approach;
- identify who does what in the field of regulatory oversight;
- provides clarity of the levels of compliance by understanding the assessment processes in each of the membership countries.

Industry

- more consistent regulatory process;
- reduced delays at regulator / industry interfaces;
- reduced number of denial of shipments.

Wider community

- contributes to a basis of confidence that the transport of radioactive material is, and will, continue to be safe;
- demonstrates that the trans-frontier transport of radioactive material is in part, being managed by European countries in a trans-frontier forum, which targets compliance and the practical issues relating to regulatory oversight and intervention.

Concluding remarks

The Association is an example of the transport safety regulatory community collaborating and working more closely together on the practicalities of regulatory oversight. This is particularly important for transport as often the



transport of radioactive goods is a global process that can involve several countries. The transport of radioactive material has an enviable safety record. The Association is an example that the regulatory community is continuing

to develop its ways of working to ensure that safety remains the number one priority and the public have a basis to accept the societal need for the transports of radioactive material to continue. ■



The European Commission's project to regulate carriers in Europe

Interview¹ with Joël Binet, Senior Assistant, General Directorate for Energy – European Commission

Contrôle : Mr Joël Binet, in issue 174 of the review *Contrôle* published by ASN in 2007, you presented the European Commission's reflections on the harmonisation of European legislation on the transport of radioactive materials. What is the situation today of what you qualified then as a legislative "jungle"?

Joël Binet : Since 2007 we have carried out a detailed analysis of the legislative framework and the various problems encountered in the international transport of radioactive materials.

This study confirmed that the legislative framework for the international transport of non-fissile radioactive material (such as products for medical or industrial uses, which represent 90% of the class 7 shipments) remains complex. This complexity results from the national deviations from the international ADR/RID/ICAO standards, and the diversity and invalidness of domestic licenses. An important step in the improvement of the regulatory framework was accomplished in 2008 with the publication of the directive on the inland transport of dangerous goods². A single directive now governs the transport of dangerous goods by road (ADR), by rail (RID) and by

inland waterways (ADN). Thanks to this directive, the rules established by the ADR, RID and ADN agreements for international transport are extended to national transport, thereby harmonising the conditions of transport of dangerous goods, including radioactive materials, throughout the European Union.

The draft regulations instituting a European Community (EC) system of registering carriers, currently being prepared, aim specifically at harmonising and collecting information relative to the notifications and/or authorisations for these shipments within the European Union.

How do the draft European regulations establishing an EC system for registering nuclear material carriers fit into a process of harmonisation and simplification of the European legislation? More specifically, what is the legal basis of this project, knowing that there already exists a directive from 2008 on the inland transport of dangerous goods, and a Euratom directive² from 1996

Transport of ore concentrates from the Niger



1. The replies given in this interview express solely the opinion of the author, and do not necessarily reflect the opinion of the European Commission.

2. Directive 2008/68/CE of the European Parliament and of the Council of 24th September 2008 relative to the inland transport of dangerous goods.



which provides for radioactive material carriers to be subject to a national system of authorisation and notification?

The Euratom directive³ of 1996 aims to protect workers and the public against the dangers resulting from activities that involve radioactive materials, including their transport. Implementation of this directive has led the member states to institute transport notification and/or authorisation systems, which differ from one country to another. The draft regulations establishing an EC system for registering carriers aims at harmonising the many different systems of notification and/or authorisation.

These draft regulations aim to replace the national systems of notification and authorisation in the member states by a single European carrier registration system. Can you explain how these regulations will meet the objectives of radiation protection of workers and the general public?

To protect workers and the general public, and to better focus on this objective, the Authorities of the member states must know which people, organisations or carrier

contractors are operating on their territory in order to better monitor them if necessary. A single centralised registration system will help harmonise registration procedures and facilitate the collection and exchange of information between the various stakeholders, particularly the competent Authorities, thereby ensuring a high level of radiation protection in the transport of radioactive materials.

The draft regulations must now be examined by the Council. Do you think this could be placed on the agenda under the Danish presidency of the EU, which began in January 2012?

The draft regulations have been analysed by the economic and social committee which submitted its opinion in February 2012, further to which the Commission will finalise the proposal and definitively adopt it. It is therefore probable that the regulations will be placed on the agenda and examined under the Danish presidency. ■

3. Council Directive 96/29/ Euratom of 13th May 1996 laying down basic safety standards for protecting the health of workers and the general public against the dangers arising from ionising radiation.

Role of the TRANSSC committee

Par Jim Stewart, Head of Transport Security Department - IAEA

The TRANSSC or "Transport Safety Standards Committee" is a standing committee set up to advise the Deputy Director General in respect to the establishing of safety standards related to transport, and on the programme for their application.

There are several ways to examine the role of the committee, the role of the committee established by the terms of reference; the role of the committee members established by the terms of reference; the role in relation to the IAEA statute; and the wider expectations.

Safety Standard production

The prime function of the committee relates to delivery of standards, not simply transport safety standards. There are three essential steps to producing standards: planning, drafting and approving, and thus the input of the committee is split into three steps. In addition a new step is being formally introduced which has been in place for some years in transport standards – a review step to guarantee they are kept up to date. Feedback is seen as the initial step in production of new or revised standards. At the planning stage a document preparation profile (DPP) is produced which sets out the reason for producing the document, the plans for producing the document and the interface requirements (amongst other

items). The first duty of the committee is to review this document and decide whether the plans are appropriate, taking into account feedback. Members of the committee are also responsible for gathering information from their state relating to the use of related standards and publications (for example where a document is being revised members should provide feedback on the use of the existing version) and sharing this with the committee. The acceptance of the DPP is achieved through a two-step process: a review and comment period prior to the TRANSSC meeting, followed by resolution of committee member comments during the meeting.

The second aspect of document production is the drafting. For transport documents it is common to allow TRANSSC members to offer support for document drafting, however under the formal process of the IAEA the committee does not draft (drafting is often carried out by one or two experts and/or the secretariat), indeed in some cases it is seen as important to separate drafting from committee work. Once a draft is ready the committee clears it to be sent for comment by all Member States. Again the process is a mixture of pre-meeting review and comment, followed by committee resolution. At this stage there should be a consensus view that the committee is content with the draft, in other words, if no comments



Technical meeting of the IAEA relative to the basis of the radioactive material transport regulations, ASN Paris – October 2010

are received from Member States the standard need not be altered.

The following Member State comment period may involve the committee member, but is not a committee activity. Nor is it a committee activity to resolve the comments from Member States (this is an activity to be carried out by the Technical officer prior to the committee for their approval), but rather the final approval stage is to ensure that Member States comments have been accounted for. The primary difference for transport as compared to other safety standards is that the regulations developed by IAEA are directly implemented in many Member States “as is” either through implementation of international agreements or direct incorporation in regulatory documents. For this reason there is a close interest in even the slightest changes to the transport regulations. As a result, in transport, there has been a tradition of involving TRANSSC in advising on the best way to develop requirements and guides.

The transport community

While the formal role of TRANSSC is related to safety standards there is a more informal role to ensure that the transport of radioactive material worldwide is safe. This is captured in different parts of the terms of reference, such as the need to present national positions, the need to provide feedback etc.

The essential message is that the role of the committee is to deliver continuous improvement to safety where gaps are identified. The provision of effective safety standards is one part of this; however the transport review deals with safety in transport – the final deliverable. This is only achievable through open sharing of experience.

During the process of revising the transport regulations two principles have been established:

During the review - if a safety “issue” or problem is identified by a Member State and agreed to by TRANSSC, then it is incumbent on TRANSSC to determine a means to address the issue. The fact that a proposed solution fails to address the issue does not make an issue disappear.

Means to address the issue can vary from amending regulations through providing additional guidance to identifying research required.

Where solutions are not acceptable the onus is on the person objecting to find a route for improvement. In other words the focus is on improving solutions to problems, not accepting or rejecting them.

Conclusion

While many formal roles can be defined for TRANSSC the idea of providing a global focal point where safety issues related to the transport of radioactive material can be raised and resolved comes closest to encapsulating the overall purpose in a single statement. ■

The need for international harmonisation experience feedback on the transport of uranium

By Colette Clémenté,
Assistant to the Director of Transport and Sources -
Nuclear Safety Authority (ASN)

The import and export of radioactive materials between France and other countries is commonplace and concerns all modes of transport. The choice of mode is made according to the material to be transported, the associated time constraints (in the case of radiopharmaceutical packages containing short-lived radionuclides, for example), the facilities of the consignor (who prepares the consignment for shipping) and the consignee (who takes delivery of the consignment), and the geography of the country to cross. The number of packages of radioactive materials transported each year in the world for the needs of industry (nuclear or not), the medical sector and scientific research is estimated at about 10 million. Because packages of radioactive materials sometimes have to cross borders, the need for common standards guaranteeing transport safety arose very quickly. The first "Regulations for the safe transport of radioactive materials", called TS-R-1, were published by the IAEA in 1961, shortly after its creation, and subsequent national and international regulations were more or less based on them.

TS-R-1 has been profoundly reworked a number of times to take into account scientific and technological progress and experience feedback in the field of transport. To facilitate its application, it is accompanied by safety guides explaining some of its prescriptions. Guide TS-G-1.1 for example is intended to clarify certain paragraphs of the Regulations, even if it not made enforceable by the international regulations. This approach thus serves to ensure consistency and reliability in the field of international transport, as these standards are applied by the designers, manufacturers and applicants in all the IAEA member states.

In this respect, one paragraph in the TS-R-1 regulations is of real interest, namely paragraph 834 which authorises automatic approval recognition between the countries. Certificate validations are common for cross-border movements, such as uranium hexafluoride (UF₆) shipments. International experience feedback from these transport operations in 2011 highlighted the need for increased cooperation between the entities responsible for transport and the competent Authorities.

On 25th March 2011, the company TN International notified ASN for the third time of an event relative to deficiencies in

the closing system of the protective overpacks used in the transport of uranium hexafluoride cylinders.

These overpacks are used for the transport of model 30B cylinders containing uranium hexafluoride used in the fabrication of nuclear fuel. The cylinder ensures the containment of the material, while the overpack ensures the mechanical and thermal protection of the cylinder and its contents.

The UX-30 overpack comprises two half-shells joined together by 10 "ball-lock pins" and two closing bands. The three events notified to ASN in 2010 and 2011 involved the unforeseen unlocking and disengagement of ball-lock pins during transport. The safety implications of these events are limited because the overpack is placed in a cradle support during transport. Moreover, two arc-shaped bands ensure continuous lengthwise contact between the two half-shells and play a role in the package closing system. The ball-lock pins are nevertheless planned for in the package design to guarantee closure of the overpack during the handling phases, including in the event of a fall.

This transport package was designed by Energy Solutions, an American company, which sold the license to the new owner, Columbian Hi Tech (CHT), on 8th March 2011. The package received an approval certificate delivered by the American Authorities.

The use of the UX-30 overpacks in France is authorised, as provided for in the international regulations, by the ASN validation of the American certificate.

The analysis of the notified events concerning the disengagement of the ball-lock pins led to exchanges between ASN and the American Authorities. This revealed that similar events had been reported to the American Authorities in the past. At that time, the American designer Energy Solutions had introduced a design modification recommending replacement of the original pins by pins that reduced the risk of disengagement and increased their strength. At the time, this modification - which had only been recorded in the restricted circulation part of the safety file (private version of the safety report) for questions of industrial secrecy - was not re-transcribed in an update of the user manuals sent to all the users, including the AREVA entities in France. Consequently, these entities had not been

of practices: hexafluoride packages in UX-30 overpacks



ASN inspection of a convoy of enriched uranium hexafluoride ready to leave the EURODIF plant on the Tricastin site – March 2010

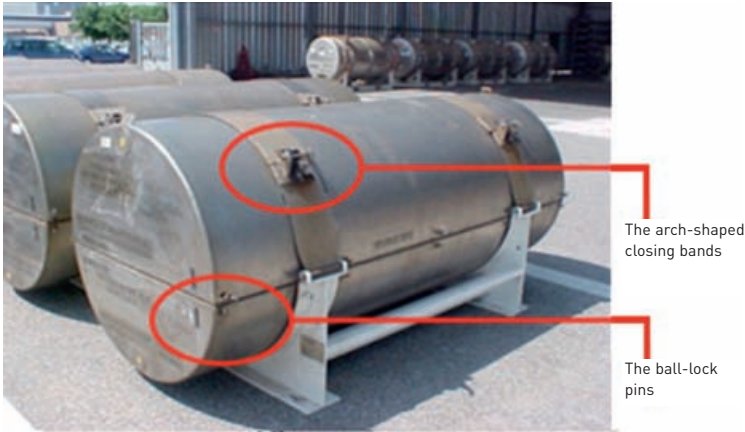

The arch-shaped closing bands

The ball-lock pins

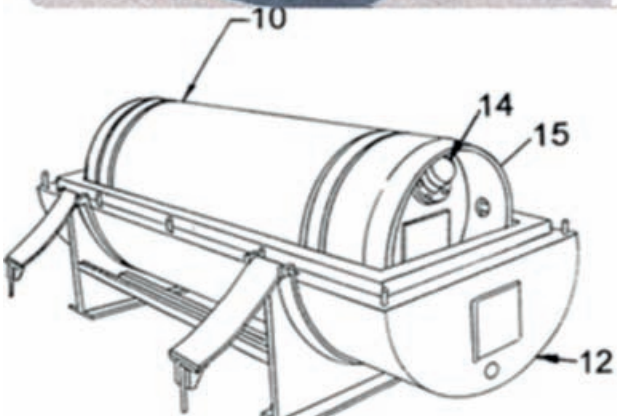

Photo and illustration of the UX-30 overpack (12). The illustration shows the UF₆ cylinder (15) with the arch-shaped closing bands open

informed of the experience feedback and the change in the pins requested in the USA.

In addition to these closing system failures, cracks were detected in the actual body of the aluminium pin during internal inspections carried out by AREVA on about twenty of its overpacks. Further to this experience feedback, the ball-lock pins that did not comply with the mechanical requirements specified in the safety file were replaced.

Despite the limited safety impact of this event, it did have economic consequences since international shipments of UF₆ from France using this package were stopped for the time required to analyse the reported incidents and implement appropriate corrective measures. Several ASN inspections of users of this overpack in France confirmed that the ball-lock pin replacements had indeed been started. ASN moreover issued a new approval certificate in July 2011, introducing specific measures concerning the inspection of the ball-lock pins before shipment.

This event shows that in spite of restrictive and widely shared international regulations, progress must still be made in the setting up of international experience feedback on the use of transport packages and on cooperation between the entities responsible for transport. A package user must demonstrate its capacity to follow the changes in package design concepts for which it does not hold the concept property rights.

First of all, it must be noted that it is the responsibility of the approval applicant to ensure that it has the information necessary for its application to be examined, and in particular all the information having an impact on the safety

of the package design during its transport. This information must be understandable to all users who at some stage will be responsible for the use and maintenance of the packages.

It would then seem fundamental that all information relating to safety should be made accessible by the original designer or applicant, including for intellectual property reasons that should not induce restricting of the availability of this information. The American designer CHT, alerted first by French, then by English and German users, quickly understood the importance of this. CHT asked all the UX-30 overpack owners to send it their maintenance and servicing procedures, and set up a working party including the users to share experience feedback on the utilisation of the packages.

Lastly, in the absence of a restrictive regulatory framework, it is the duty of the competent Authorities to disseminate the information as soon as events of this type are brought to their notice. This is what ASN did by contacting the NRC (United States Nuclear Regulatory Commission) very rapidly and informing the European transport Authorities of this event through the European Association of Competent Authorities (EACA) on the transport of radioactive material. This European body is not part of a regulatory framework, but arose from the need for the Authorities to work together and have exchanges in relation to their field of activity, particularly with regard to package design approvals, inspections, keeping track of regulations, and experience feedback on incident events. AREVA, for its part, proposed organising the sharing of experience on the transport packages common to the various users, through the World Nuclear Transport Institute (WNTI), an association of radioactive material transport players.

This initiative will make all the users and owners of UX-30 overpacks in the French fleet aware of what the NRC now calls "the UX-30 case". ■

Photo of the ball-lock pins (on the right of the photo): the ball-lock pins mounted on one half-shell lock into a hole in the other half-shell when the protective overpack is closed





ASN inspection of a convoy of enriched uranium hexafluoride ready to leave the EURODIF plant on the Tricastin site – March 2010

The international and european regulations

The International Atomic Energy Agency (IAEA) produces recommendations (TS-R-1 – Regulations for the Safe Transport of Radioactive Materials). Their purpose is to establish the requirement that must be satisfied to ensure safety and protect persons, property and the environment against the effects of ionising radiation in the transport of radioactive materials. The legislation applicable to the different modes of transport is established by international or European organisations on the basis of these recommendations.

Examples include:

- for road transport, the European Agreement concerning the International Carriage of Dangerous Goods by Road (ADR – <http://live.unece.org/trans/danger/danger.html>);
- for rail transport, the Regulations concerning the International Carriage of Dangerous Goods by Rail (RID – www.otif.org);

- for maritime transport, the International Maritime Dangerous Goods Code (IMDG – www.imo.org);
- for air transport, Appendix 18 to the Chicago Convention on International Civil Aviation (ICAO – www.icao.org);
- for inland waterway transport, the European Agreement concerning the International Carriage of Dangerous Goods by Inland Waterways (ADN – <http://live.unece.org/trans/danger/danger.html>);

The European Directive 2008/68/CE of the European Parliament and of the Council of 24th September 2008 on the inland transport of dangerous goods (<http://eur-lex.europa.eu>) renders the ADR, RID and ADN agreements enforceable on the territory of the European Union.

These regulations are supplemented in France by the order of 29th May 2009 amended, relative to the inland transport of dangerous goods (called the TMD order):

<http://legifrance.gouv.fr> ■

Colonel Christian Riach is Head of the Nuclear Security Department in the Ministry of Ecology, Sustainable Development, Transport and Housing (MEDDTL). He explains his duties and the relations he maintains with the Defence High Official (HFD), ASN, and the Ministry of the Interior, to ensure the protection and regulation of nuclear materials.

Protecting shipments against malicious acts

Contrôle : Colonel, you direct the Nuclear Security Department within the MEDDTL. What is your remit, particularly in terms of the transport of nuclear materials?

Colonel Christian Riach : The Nuclear Security Department implements all the responsibilities of the competent minister in terms of nuclear security, be it for facilities or transport. It has three chief duties, namely to regulate, to authorise and to oversee. The regulations were substantially updated in 2009 and 2010 (see box on page 19), but as you will understand, this task is never finished and requires keeping a permanent watch over the changes in the threats and the international recommendations. I would point out that in the nuclear field, security means protection against theft, misappropriation, and malicious acts. To transport nuclear materials, it is firstly necessary to be "an authorised carrier", that is to say have approved equipment and demonstrate the capacity to meet all the regulatory obligations, and then obtain a "transport security authorisation" for each transport operation. Lastly, oversight occupies an important position, involving technical inspections of the vectors, real-time tracking of shipments (see the role of the EOT - transport operations section) and unannounced inspections during transport.

What are the means at your disposal?

My department is organised around three offices, one for the nuclear facilities, one for transport and training, and one for international relations. We also receive substantial technical support from the IRSN. The IRSN analyses the authorisation files and transport security authorisation applications, then ensures the operational tracking for us. It is also a valuable source of inspectors. We thus empower about fifty sworn-in people to carry out inspection missions.

What is the sensitivity of these shipments?

The question of sensitivity is interesting, because everyone uses this term, but with very different meanings. Sensitivity can effectively be considered in terms of media impact, political acceptability, public opinion, safety due to the potential consequences of an accident, and so on. These

notions rarely intersect one another. As far as security is concerned, the sensitivity is defined by the regulations (PCMNIT¹ decree) which classify materials in three categories. Category 1 is the most highly protected, as these materials could be used in the making of weapons, and this transport activity is therefore covered by French national defence secrecy. To clearly understand this classification, it must be remembered that the regulations were historically developed in a logic of "non-proliferation" and therefore chiefly target the vulnerability to theft or diversion. Whatever the case, close relations are maintained between the HFD, ASN and the ministries concerned, and especially the Ministry of the Interior. These relations and the procedures in place serve to ensure compliance with the obligations and responsibilities of each entity and that the constraints are taken into account.

What measures are taken to ensure this security?

The transport operations are very varied, and we deal with about 1,800 per year. They last from a few hours to 75 days and use different modes: rail, road, sea, air. The activities associated with the nuclear power plant fuel cycle represent the major part, while the remainder concerns research, industry and the medical sector. Thus in 2010, nearly 120 shipments transported targets for the production of isotopes for medical uses, or fuel for research reactors. Materials do not all display the same vulnerability, therefore they – and their shipment – do not all receive the same treatment. The category 1 materials, the most sensitive in the terms of the regulations, must be escorted. They are subject to specific tracking, provisions and arrangements which, as everyone will understand, are classified as "confidential". This being said, the majority of the regulations that set the obligations are on open source, which allows anyone who so wishes to find out the level of security protection applied to the transport operations. ■

1. Decree 2009-1120 of 17 September 2009 (called the PCMNIT decree) on the protection and control of nuclear materials



Denis Flory at the international conference on the safe and secure transport of radioactive materials

Synergies between security and safety: lessons learned from the international conference of the IAEA

By Denis Flory, Deputy Director General, Head of the Nuclear Safety and Security Department – IAEA

During the week of 17th October, the IAEA hosted the International Conference on the Safe and Secure Transport of Radioactive Material, exploring transport safety and security. The underlying message was that no amount of paperwork, whether regulations or approvals could provide safety and security in transport; safety and security required effective application of requirements. The conference explored both the philosophical and the practical aspects of safety and security working together in transport.

Two top down structures for IAEA documents

The basis for and content of the IAEA safety standards series and nuclear security guidelines were discussed. Both document series follow a top down structure, starting at the top with Fundamentals. Ershov, et al, reviewed this top level, identifying three security fundamental principles (F, H and I) having safety analogies that were not recognised as fundamental principles.

For example, Nuclear Security Fundamental Principle H: *Graded Approach*, states “Physical protection requirements

should be based on a graded approach, taking into account the current evaluation of the threat, the relative attractiveness, the nature of the material and potential consequences associated with the unauthorized removal of nuclear material and with the sabotage against nuclear facilities or nuclear material.”

There can be no argument that a similar concept of graded approach applies in the safety realm. Similarly the Nuclear Security Fundamental Principle F: Security Culture has an obvious analogy in safety culture, and the Nuclear Security Principle I: Defence in Depth is a well-known safety concept as well.

If the fundamental principles were either matching or only applied to their particular area (either security or safety) the questions would be easier to answer. However the fact that some fundamental principles in one area are treated as lower level concepts in the other areas leads to significant questions because of the top down structure. Is it indeed possible that similar concepts have a different level of importance in safety when compared to their level of importance in security?





If the answer is yes, then the possibility of a single harmonised set of documents comprising both safety and security provisions seems like a difficult goal because of their theoretical differences. However, it would seem more likely that the answer is that the concepts can be harmonised. But this raises equally difficult problems, not related to theory, but to their practical delivery. As I pointed out in my paper to the conference, the Security Fundamental Principles are tied to the language of the conventions; therefore, it would seem easier to adjust the safety fundamentals to match the security fundamentals. But having almost completed the safety requirements related to the safety fundamentals in a top down structure is it reasonable to start a complete revision based on new fundamentals?

Fortuitously the International Air Transport Association (IATA) offered a view to harmonise safety and security concepts, suggesting that document structure was not an essential element or achieving harmony between the two.

Bottom up approach

An alternative approach offered to Nuclear safety and security in transport was to first consider the end user needs. For many years, it has been recognised that the end user (at least in the nuclear field, if not in the radioactive material field) needed to consider both safety and security together in transport. The idea of an *"accident anywhere is an accident everywhere"* has been repeated many times recently. This concept is particularly the case in radioactive material international transport safety and security: whereby a failure in any country, in either safety or security, can lead to a problem, or failure in another country.

The "fundamental principle" in this bottom-up approach is that there needs to be international harmonisation of the application of effective safety and security concepts, thereby providing each Member State with safety and security.

This creates a very different process to the idea of top-down harmonisation. This results in the emphasis in raising the level of application of standards of transport safety and security arrangements based on a Member States needs assessment. This offers a very clear and simple synergy in terms of safety and security – should there be separate considerations of safety and security needs, or should there be a single, consolidated view produced? This bottom-up approach offers to deliver almost immediate benefits, something of interest to both safety and security.

A side benefit is that this work would match very closely to the work required to deal with the "denial of shipment" problem, through greater familiarisation, transparency and harmonisation of standards and improved operator training. In this respect, the synergy could be seen to extend to ensuring that both security and safety capacity building ensued for all. The benefits of security personnel understanding safety concepts—and vice versa would most likely offer benefits as higher levels are considered.

The most immediate level of IAEA documents working from the bottom up are functional guides. Currently, a safety guide exists on how to ensure compliance – this is in the safety area.

A security guide is being developed on how to identify illegal shipments. The extent to which both of these guides can exist separately would be brought into question by the bottom up approach. For example, a package that is not compliant from a safety standpoint could also be a security concern. Likewise, a package that has contents that cannot be verified from a security viewpoint is almost certainly a safety concern in some respects.

Should a non-compliant package in relation to safety considerations be held in the location found, or should it be moved to a secure location? It must be considered inevitable that illicit trafficking involves a breach of safety regulations. There can be no doubt that not only the operator but also the regulator needs to consider safety and security together in a practical sense when it comes to transport.

This bottom up approach seems to offer, or perhaps even drive, the delivery of synergies between safety and security.

Process synergies

A further issue brought out during the conference was the IAEA safety and security document production process differences. Content differences between these two series makes this variation even more significant. Security always has been an area with more State involvement, yet safety standards are required to be approved by the Board of Governors; security guidance that contains more provisions targeted at a higher level does not require approval by the Board of Governors. While this raises issues regarding the correct process for both safety and security documents, it can open doors to synergies in the production process.

Practical synergies

On practical grounds, there were differences identified that required reconciliation, such as information flow: the freedom of or the restriction from communication. However, concepts were put forward that offered ideas of technical synergies. For example, the design of packages for safety purposes could easily provide effective delay mechanisms that could be considered in security.

Conclusions

While there remains work to be done to develop the conference findings into activities, there are clear examples where documents and provisions in safety and security can be developed in a way which offers some synergies. However, it seems likely that the most immediate gains and synergies can be found from a bottom up approach, focusing on harmonised achievement of acceptable levels of safety and security across all Member States. The major immediate synergies would not seem to come from harmonisation of safety and security, but more through harmonisation of process. To this end the ability to work with other UN partners, such as International Civilian Aviation Organization (ICAO) and International Maritime Organization (IMO) that have established both safety and security provisions offers further opportunities for synergies.

Whether this is a direction that Member States wish to take will be discussed at an IAEA meeting in March 2012. ■

Assessment of the IAEA international conference on the transport of radioactive materials

On the occasion of the fiftieth anniversary of the IAEA Regulations for the Safe Transport of Radioactive Material, TS-R-1, an international conference on the safety and security of transport of radioactive materials was held in Vienna from 17 to 21 October 2011. During this conference, the reflections focused on the creation of a safe, secure and lasting framework for the next fifty years.

More than 250 people from sixty countries attended this conference. ASN Chairman, Mr André-Claude Lacoste, took the floor as Chairman of the IAEA Commission of Safety Standards (CSS). After evoking the history of nuclear material transport, he addressed the five major challenges lying ahead:

- improving the synergy between transport safety and security;
- maintaining consistency between the requirements of the TS-R-1 regulations and those of the UN Orange Book;
- promoting transparency in the field of nuclear safety;
- drawing the lessons from the Fukushima accident;
- developing exchanges of good practices between the transport stakeholders.

The following notable points emerged from the subjects broached:

Harmonisation

It is important to implement international harmonisation between:

- the safety and security requirements at both national and international level, to reduce divergences between the different regulations;
- the IAEA and the other United Nations organisations.

A cooperation and coordination effort with the emerging countries would be beneficial for the development of their competent Authorities.

Transport delays and refusal

For many years, industry and the health sector have

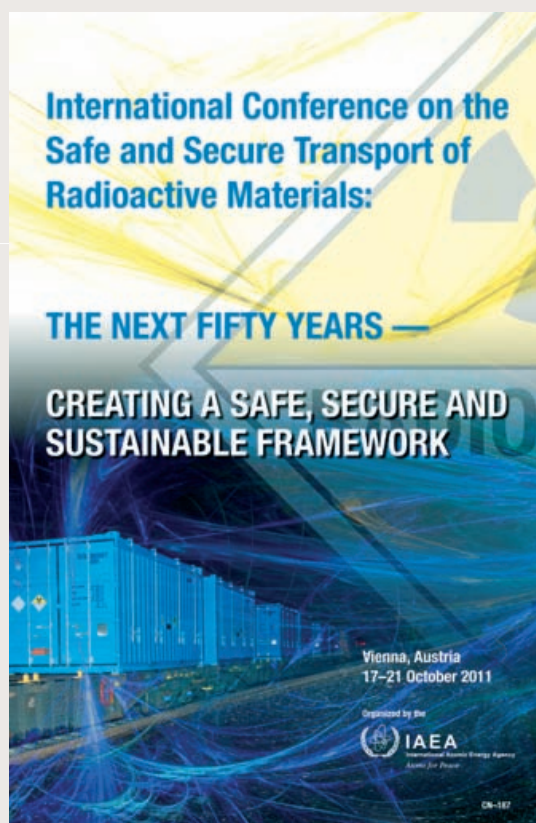

Poster of the IAEA international conference on the transport of radioactive materials

reported difficulties in the transport of radioactive substances.

These difficulties can be of two types: refusals to transport or delays in transport. A transport refusal is when the refusal to transport the radioactive substances is expressed explicitly or implicitly (e.g. refusal by an aircraft pilot to load a package containing radioactive materials), even though the shipment complies with the applicable regulations. A transport delay is when carriage is postponed or shifted in time, even though here again the shipment satisfies the applicable requirements.

These difficulties mainly (70%) concern carriers (airlines or shipping lines) who refuse or defer the shipment of any cargo loaded with radioactive substances.

The participants concluded that harmonisation of application of the regulations, including the regulatory procedures and good practices, is necessary to avoid transport refusals.

Transport delays and refusals effectively continue to be a problem that must be dealt with.

They can just as well affect security. For example, ■ ■ ■



a package left in a facility could be abandoned or lost. Efforts to reduce these refusals will have beneficial effects on both safety and security.

Transport refusals also hinder deliveries of sources (e.g. short-lived radionuclides for medical purposes) and their return to the supplier.

Safety prescriptions and security recommendations

The graduated approach to the risk must be based on both safety and security.

The consistency between the different translations must be verified in order to clarify the regulatory prescriptions (for example, the French words “sûreté” and “sécurité” may both be translated by “safety”, or else by “safety” and “security” respectively, depending on the regulations).

Emergency intervention

An effective emergency intervention requires international cooperation. In this context, the IAEA services can assist States in their preparation for emergency situations and during interventions.

The continuous exchange of information can facilitate the IAEA's action and its participation in informing the public.

Communication

It is necessary to make the public aware of transport safety and security measures. Ways of increasing transparency should be explored, while taking into account the need for confidentiality to ensure security.

The conference presentations are available on the IAEA web site. (www.iaea.org) ■

The role of the IRSN's transport operations section in the field of security

By Olivier Loiseau, Head of the Office of Transport Security and Support for the Protection of the Facilities of the Defence, Security and Non-proliferation Unit, and Frédéric Mermaz, Head of the Technical Support and Studies Service of the Defence, Security and Non-proliferation Unit – Institute of Radiation Protection and Nuclear Safety (IRSN)

The EOT (transport operations section) of the IRSN (Institute of Radiation Protection and Nuclear Safety), is responsible for managing and processing nuclear shipment transport authorisation applications, tracking these shipments, and transmitting any alerts concerning them to the Authorities. This security role, defined by the order of 18 August 2010, can be set out in three phases, depending on whether the EOT intervenes before, during or after the transport operation. Prior to any transport operation, the defence code obliges the carriers to obtain a transport security authorisation. The EOT examines the

corresponding application files. This examination consists in verifying the conformity of the planned provisions with the requirements specified in articles R.1333-17, 18 and 19 of the Defence Code and in the order of 18 August 2010. For the majority of shipments, the period of notice for filing the application is set at fifteen days before the date of departure. On completion of the examination, the EOT issues an opinion for the attention of the competent security Authorities. For shipments being transported to or from a foreign country, the transport security authorisation is delivered by the Minister of

Energy or the Minister of Defence, within their respective areas of responsibility. For domestic shipments, it is the Deputy Director General of the IRSN who issues the transport security authorisations.

The EOT ensures permanent tracking during the transport operation. For this purpose it is organised in two teams, each working a shift of eight hours per day. Operational tracking is based firstly on the GPS positioning of the conveyances (means of transport) and the supervision of alarms linked to sensors monitoring the security functions, and secondly on a permanent communication link with the transport crews, and on protocols established with the rail carriers or the port or airport infrastructures. The communication lines and actions are ensured using specific means that guarantee confidentiality of information exchanges.

This permanent link with the carriers enables the EOT to be the first alerted in the event of an incident or accident, and to transmit the information required for managing the event if necessary.

Lastly, on completion of a transport operation, the EOT processes and files the essential information relative to that operation. This information can be used to make comparisons with the nuclear material movement declarations addressed to the IRSN for national accounting, or to establish statistical reviews of the movements of certain materials.

In the context of its duties, the EOT thus has an overall view of ongoing nuclear material shipments on the French territory, and reliable information – updated in real time – on their level of security. ■

Transparency and secrecy in the area of nuclear material transport

By General Laurent Demolins, Deputy Defence and Security High Official, Head of the Defence, Security and Economic Intelligence Service

In terms of nuclear security, within the meaning of article 1 of the “TSN” Act 2006-86 of 13 June 2006 relative to transparency and security in the nuclear field, this act is the reference. It devotes its title II and the 13 articles thereof to the ASN, for which it specifies the role and modes of action. With regard to transport, although the act contains a title IV devoted to basic nuclear installations and the transport of radioactive materials, the transport aspect is addressed mainly from the viewpoint of the inspections and policing measures necessary to ensure compliance with nuclear safety rules. As for public information on nuclear safety, this is covered by title III of the TSN Act (comprising 3 chapters and 10 articles). Transparency in this latter domain is total when it comes to informing the public “about the modes and results of nuclear safety and radiation protection monitoring”. Article 19 specifies that “any person is entitled to obtain... from the persons responsible for transporting radioactive materials...the information held...on the risks related to ionising radiation... and the safety... measures...”.

The attentive reader of the TSN Act will observe that it in no way indicates that transparency obliges the licensee, ASN, or the State, to inform the public of the details of the organisation of transport operations, including in particular the dates of transport and the routes taken. This cannot be an accidental omission, but indeed the deliberate will of the legislator, provided for by the act of 17 July 1978 to improve relations between the administration

and the public, not to communicate various administrative documents that could jeopardise public security or the safety of people.

By way of example or comparison, nobody – unless ill-intentioned or irresponsible – would consider publicising the dates and times of cash or precious material transport movements.

The line between transparency and secrecy is thus regulated by the two abovementioned acts, which must be taken into consideration by ASN and the licensees, taking care to avoid any excesses or failings. In parallel with this, the Convention on the Physical Protection of Nuclear Materials, adopted in Vienna on 8 July 2005 and currently being ratified by France, introduces confidentiality as one of the fundamental principles aiming, among other things, at protecting against theft and sabotage. On this account, its article 2A specifies that “The State should establish requirements for protecting the confidentiality of information, the unauthorized disclosure of which could compromise the physical protection of nuclear material and nuclear facilities”.

More specifically, the decree of 17 July 1998 relative to the protection of national defence secrets, which was adapted via the order of 26 January 2004 relative to the protection of national defence secrecy in the area of protection and regulation of nuclear materials, enables the



Safety and security, two notions that must not be confused

The act relative to transparency and security in the nuclear field codified by the order of 5 January 2012 defines “nuclear security” and “nuclear safety”:

- **nuclear security** comprises nuclear safety, radiation protection, prevention and combating of malicious acts, and civil protection actions in the event of an accident;
- **nuclear safety** encompasses all the technical provisions and organisational measures relative to the design, construction, functioning, shutdown and decommissioning of basic nuclear installations, and the transport of radioactive materials, taken with a view to preventing accidents or mitigating their consequences.

The expression “*sécurité nucléaire*” is often used in France as a literal translation of the English “nuclear security, which, according to the IAEA glossary, designates the prevention and detection of thefts, sabotage, unauthorised access, illegal transfers or other malicious acts involving nuclear materials, other radioactive substances or the associated facilities, and the intervention measures. In this area, it is the services of the High Official of the Ministry in charge of Ecology who exercises the role of Authority, by delegation from the Ministries of Defence and Energy.

Outside the nuclear domain (transport of dangerous goods other than class 7, and in ICPE’s - installations classified on environmental protection grounds), the two notions of **safety** and **security** have meanings that are directly opposed. In the field of transport of dangerous goods other than class 7:

- the term “**safety**” means the measures or precautions to take to minimise the theft or inappropriate use of dangerous goods that can endanger persons, property or the environment (European Agreement concerning the International Carriage of Dangerous Goods by Road - ADR chapter 1.10);
- the “**security**” of transport corresponds to the objectives of “limiting or reducing risks, accidents, harmful effects” (Transport Code, article L. 1111-1).

Security in the field of dangerous goods transport is therefore equivalent to the notion of nuclear safety in the nuclear domain. ■

HFDS to classify all or part of the information relative to these transport operations.

Over and beyond these clarifications, everyone will note that the nuclear world and that of nuclear materials transport are no exception, and that the rules of confidentiality or secrecy - which are not always compatible with information transparency - apply in numerous domains. One can thus mention the levels of protection of information concerning national defence and State security, diplomatic secrecy, secrecy of inquiry and investigation, secrecy of correspondence, secrecy of correspondence by telecommunication, not to mention medical confidentiality, bank secrecy, business secrecy, trade secrecy, professional secrecy, confidentiality of sources for journalists, law firm confidentiality, etc.

The obligation of confidentiality therefore covers a wide field, whether considering defence and national security, protection of public order, family interest or an economic interest. This is a protection right that is mentioned in both the Criminal Code and the Civil Code. The Criminal Code (article 226-13) punishes the disclosure of confidential information by any person having received it, either by condition or profession, or due to a post or temporary assignment.

Article 413-10 of the same code punishes the disclosure of a national defence secret by 7 years of imprisonment and a fine of up to 100,000 euros.

Though several legislative texts have clarified or modified the normative framework relative to transparency or secrecy in the last thirty years and since the law of 17 July 1978, they all contribute towards the same objective, namely to organise the transparency of the management of secrecy¹. The scope of secrecy is becoming clearer and is losing ground to that of information and transparency. This increased codification now offers more guarantees to the citizens and prevents an excessively abusive use of secrecy. The limits of secrecy are just as codified, and remain those of the national interest. ■

1. Act of 10 July 1991 relative to the secrecy of correspondence, act of 8 July 1998 instituting a national defence secrecy commission, so-called “TSN” act of 13 June 2006, act of 29 July 2009 relative to places housing national defence secrets.

The regulation of nuclear materials

“Within the meaning of the Defence Code, the term nuclear materials designates fissile and fertile materials (uranium, thorium, plutonium, tritium, deuterium and lithium 6, the latter two materials not being radioactive), which can be used for the production of a nuclear explosive device (art. R-1333-1.)

The French regulations applicable to nuclear materials, facilities and the associated transport operations, contain texts drawn from legislation, decrees and implementation orders. These texts fall within:

The Defence Code:

- the legislative (L-1333) and regulatory (R-1333) sections relative to the protection and regulation of nuclear materials;
- the legislative (L-1332) and regulatory (R-1332) sections relative to the security of vitally important activities;
- the national nuclear security directive taken in application of section R-1332 of the Defence Code;
- the implementation orders of section R-1333 of the Defence Code:
 - order relative to the conditions of application and the form of the authorisation required by article L1333-2 of the Defence Code,
 - order relative to the physical protection of facilities housing nuclear materials for which possession requires an authorisation,
 - order relative to the conditions of performance of the study provided for in article R1333-4 of the Defence Code for the protection of nuclear materials and their facilities,

- order setting the conditions of implementation of physical tracking and accounting of nuclear materials for which the possession requires an authorisation,
- order relative to the physical tracking, accounting and physical protection measures applicable to nuclear materials forming the subject of a declaration, and to the form and conditions of the declaration,
- order relative to the composition and functioning of the advisory committees of experts on the security of the facilities, structures and nuclear shipments provided for in article R1333-5 of the Defence Code,
- order relative to the protection and regulation of nuclear materials during transport,
- three orders relative to the conditions of approval of conveyances (means of transport) used for nuclear materials.

Acts and decrees:

- act 2006-686 of 13 June 2006 (also known as the “TSN Act”) relative to transparency and security in the nuclear field,
- decree, called procedure, 2007-1557 of 2 November 2007 relative to basic nuclear installations and to the regulation of the transport of radioactive materials in terms of nuclear safety. ■

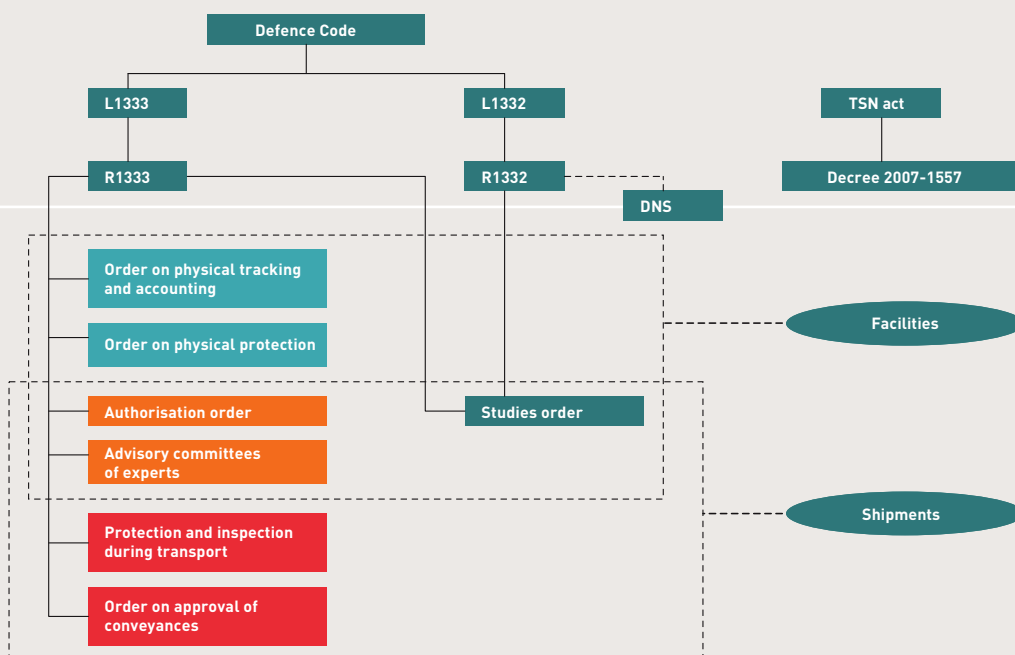

The pre-departure inspection of the Franco-German convoy

By Julie Krochmaluk, Inspector,
Transport and Sources Department –
The Nuclear Safety Authority (ASN)

On 23 November 2011, the twelfth and last convoy transporting vitrified waste resulting from the reprocessing of German spent fuel left the La Hague site to make its journey back to Germany. This convoy carried 11 CASTOR HAW 28M packages, each containing 28 CSD-V canisters (except for the last package which only contained 21). One CSD-V canister can condition 56 kg of fission products in a glass matrix within a metal container. Its total weight is 490 kg, of which 400 kg is glass.

The 28 CSD-V canisters contained in a CASTOR HAW 28M package correspond to the high-level long-lived waste from the reprocessing of more than 80 fuel assemblies.

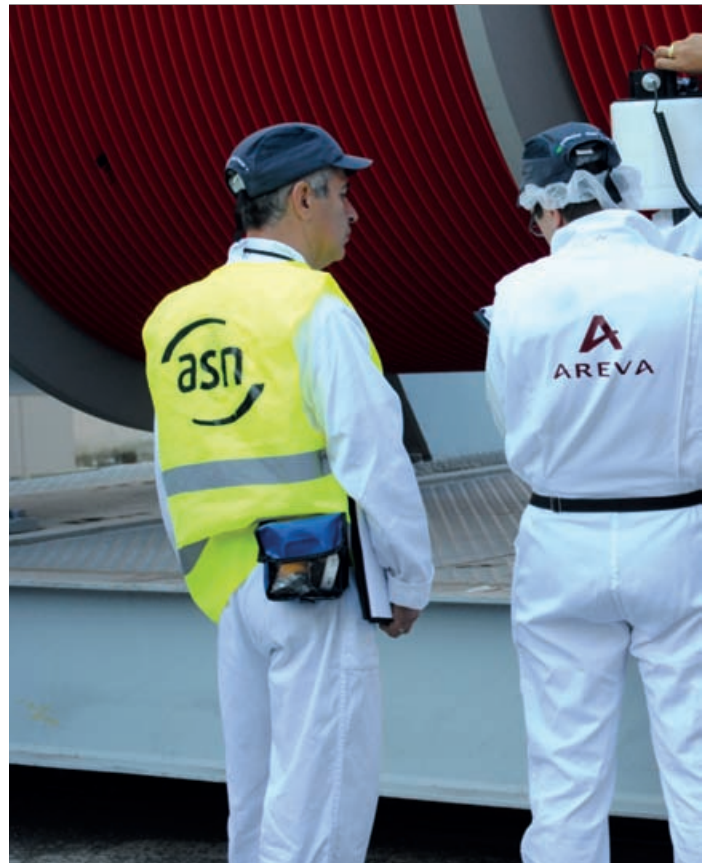

This transfer of CSD-V canisters from La Hague to Gorleben in Germany was planned for by the October 2008 signing of an intergovernmental agreement between France and Germany governing the return to Germany of the radioactive waste from the reprocessing of spent German fuel on the La Hague site. Under this agreement, France and Germany gave their commitment to return the high-level vitrified waste (CSD-V) before 31 December 2011.

In the case of the last shipment of November 2011, ASN carried out several inspections with the different entities involved in the transport operation.

ASN firstly examined the package design approval application to verify that all the requirements of the regulations were satisfied. This is because, as a type B package design containing fissile material, the "CASTOR HAW 28M" package loaded with containers of vitrified waste must guarantee the maintaining of the functions of containment of the radioactive material, of sub-criticality and of radiological protection under all circumstances, including a severe transport accident (drop tests from 9 m onto an unyielding surface and 1 m onto a puncture post,



Vitrified waste canister (CDS-V)

Compacted waste canister (CDS-C)

Trial loading of a canister into a CASTOR HAW 28M package

tions



ASN inspection on the site of La Hague on 27 and 28 september 2011

ASN also verified compliance with the regulations by performing inspections on the transport convoys. ASN thus organised an inspection on 27 and 28 September 2011 on the La Hague site to check AREVA NC in its role as consignor in the preparation of the packages. The ASN inspectors verified by random sampling that the prescriptions of the safety file and the approval certificate were carried over in the procedures implemented on the La Hague site. They notably inspected the loading plan for the contents of three packagings, and the inspections to be performed on the packages:

- radiation protection (measurements of dose equivalent rates, measurements of non-contamination);
- leak-tightness;
- package surface temperature;
- conformity of the characteristics of the loaded content with that described on the certificate.

The inspectors also examined the training of the operators working on the packages and the presence of signalling (marking of packings and labelling).

For this inspection, ASN mandated experts from the IRSN to perform radiation protection repeat-measurements around the packages. The purpose of this operation was to verify compliance with the maximum radiological exposure values in contact with the packages and the validity of the measurements taken by the consignor and used to calculate the transport indices.

on.asn.fr

■ Special report on the transport of radioactive materials



CASTOR HAW 28M package

Exploded view of the package

followed by a totally enveloping fire test at 800°C minimum for 30 minutes. An immersion test in water is also required).

After examination, the CASTOR HAW 28M package designs were approved by the German competent Authority and by ASN (French certificate of validation F/667/B(U)F-96 (Ab) of the German approval D/4325/B(U)F-96 (Rev.1)).

ASN organised a second inspection at the La Hague rail terminal on Friday 18 November 2011 to check the organisation of the convoy. Three entities involved in the transport were inspected: the consignor, the road haulage carrier, and the loading/unloading company.

1. The consignor: in the context of this inspection, the main objective is to verify compliance with the maximum radiological exposure values around the rail convoy, in contact with the wagon and at a distance of 2 metres from it. For this inspection, ASN called upon experts from the IRSN and the ACRO (Association for the Control of Radioactivity in West France) to take the measurements. The conformity of the transport documents and the traceability of the pre-shipment inspections were also examined by ASN.

2. The carrier: when one of the CASTOR HAW 28M packages arrived at the Valognes rail terminal, transported on board a vehicle, the ASN inspectors verified compliance with the prescriptions of the ADR applicable to the carrier concerning the conditions of carriage by road. The documents and

equipment present on board the vehicle, the vehicle signalling and placarding, and the training of the crew were verified.

3. The loader/unloader: ASN attended the unloading of a CASTOR HAW 28M package from the road vehicle and its loading onto a railway wagon. It observed the securing of the package to the frame provided for the rail transport and checked that appropriate equipment was used for the different operations. The general organisation in place on the site was also evaluated. ASN also examined the company's radiological protection programme, the actions of the Transport Safety Advisor (TSA), and the technical training and radiation protection training programmes followed by the employees on the job.

As is the case with all inspections performed by ASN, a summary of the inspection and any ensuing demands are given in a follow-up letter sent to the inspected company. All the follow-up letters are posted on the ASN web site.

The sanctioning powers of the ASN inspectors

As in the other sectors covered by the ASN inspectors, the inspections can have administrative or legal follow-ups. The least penalising sanction is the notice to comply, which obliges the offender to carry out the works. The sanctions can be administrative, such as the withdrawal of an approval, or penal, in case of a serious infringement.

Three texts enable the inspectors to draw up a report that can result in sanctions in the area of radioactive material transport:

- the "TSN Act" 2006-686 of 13 June 2006, and in particular its article 48, now codified in the Environment Code;
- the Transport Code, particularly its articles L. 1252-5 and subsequent;
- decree 77-1331 of 30 November 1977.

In the event of infringement of the requirements, these three texts provide for sanctions ranging from immobilisation of the vehicle by the land transport regulation inspectors, with an obligation to take corrective measures (use of a vehicle that can create a high risk of death, serious bodily harm or environmental damage), to fines of the 5th category (€1500 maximum, in the case of package labelling errors or exceeding maximum weight allowances) and prison with fines in the most serious cases: failure to notify an incident, or the transport of radioactive materials without approval or in breach of the prescriptions for the materials.

To date, ASN has applied no criminal sanctions in the field of radioactive material transport. ■



ASN inspection at the Valognes terminal on 18 November 2011: independent radiation protection measurements taken by IRSN and ACRU for ASN



Unloading from the road transport vehicle



Bolting the CASTOR HAW 28M package onto its chassis

As regards the transport of the CASTOR HAW 28M packages, the inspectors found nothing that called into question the departure of the convoy: corrective actions were performed immediately further to the inspectors' remarks.

For the CASTOR HAW 28M convoy, ASN was able to fully accomplish its tasks with the entities involved:

- the package designer during examination of the approval application;
- the consignor during the preparation and pre-departure inspections;
- the road haulage carrier;
- the loader/unloader during the change of mode of transport.

The role and responsibilities of each entity with respect to transport safety are clearly defined by the regulations; ASN's role is to ensure compliance with the regulations. ■



The supervision of radioactive material shipments: an extensive approach to the safety of transport operations

By Marc Lebrun, Transport Supervision Director – AREVA

In 2006, AREVA's senior management gave its Logistics Business Unit a "transport supervision" assignment which, still today, obliges it to carry out or at least supervise the transport of radioactive materials presenting a specific risk.

This role is perfectly complementary to the strict application of the national and international regulations on radioactive material transport safety. It takes up the regulations' general principle of risk control in the context of operations that are sensitive due to their nature. But in its "supervising" of radioactive material transport, AREVA takes the logic of precaution well beyond the field of safety in the strict sense of radiation protection: ensuring safe transport necessarily implies identifying and controlling ALL the risks created by the operation (safety, physical protection, media coverage, geopolitical risks, etc.).

The following paragraphs evoke the guidelines, the organisation and the resources that enable this ambition to be applied at operational level, in the context of the transport operations carried out by the AREVA Logistics Business Unit each year, plus the outsourced operations – in this case the contractors must be supervised – and often in an international environment.

As regards the safety of transport of radioactive materials in particular, AREVA considers that the cost of doing nothing is sooner or later far outweighed by the savings made by limiting the inspection resources and procedures – it is the very continuation of the activity that is at stake.

The deployment of transport supervision therefore illustrates a credo: beyond the strict application of the standards in effect, safety is inseparably dependent on the proactiveness and constant vigilance of the operators.

What is essential for true control of the transport risks is to have an overall view to avoid focussing solely on the operations. Supervision can also be broken down into several fields:

- prior to the transport, by the permanent deployment of risk identification, evaluation and minimising measures;
- in an operational context, by monitoring the shipments and entities involved;
- in emergency management, in the event of an incident or accident.

The approach initially consists in identifying and analysing all transport movements that can represent a risk for the AREVA group. 1,500 transport movements inducing about 10,000 operations (of which 3,000 are monitored in real time) are thus covered each year and 33 AREVA industrial sites are concerned. Exhaustive information is gathered for all the transport movements carried out or supervised by the group's Logistics Business Unit for subsequent assessment of the level of risk, operation by operation.

When a transport movement or problem requires a very detailed analysis, the Logistics Business Unit devotes a technical study to it. The studies can meet demands from AREVA group entities wishing to start transport operations or evaluate a mode of transport (maritime for example). In



other cases they follow on from an initial risk analysis and shed light on a specific subject. In such cases they must guide the operators concerned in the implementation of measures guaranteeing strict application of the transport technical and regulatory specifications. The studies cover a vast thematic field and require varied expertise: organisation of transport, regulatory watch, safety, security, loading and securing, and even public information. The Logistics Business Unit conducted no fewer than 20 studies in 2010.

Ultimately, two criteria determine the risk assessment: the level of the transport risk, determined by comparing



**TNI/AREVA
emergency centre**

the severity of a possible incident and its probability of occurrence, and the proficiency of the operator in terms of risk control. This matrix enables the riskiest movements to be classified, integrating the questions of safety, security, industrial risk and media impact risk. It also allows the elimination of transport movements, operators or means that are negatively assessed. In the area of maritime transport, nine ships have thus been excluded since 2007. According to this assessment process, and before application of improvement measures, it was established that 19% of the shipments currently supervised by AREVA in principle involve a very low level of risk, 75% a moderate or relatively moderate level of risk, and 6% a high level of risk (in which case the highest level of risk control is required).

Supervision in the actual transport phase is carried out more practically, with on-site deployment – on the sites of the consignor (sender) and consignee (addressee) in particular – of a team of inspectors qualified to inspect all the recorded movements and all the service providers. The inspectors are thus fully conversant with the national and international regulations governing the transport of class 7 materials, and have a high standard of technical knowledge (general mechanics in particular), enabling them to understand a logistics operation from start to finish.

Since its creation in 2007, the inspection team has carried out over 1100 in-depth inspection operations on all the modes of transport used by AREVA. In addition to the 250 inspections carried out annually in France and abroad, some forty audits are performed each year with players in the logistics chain. Between 2007 and 2011,

the level of “unsatisfactory” on-site inspections fell from 20% to less than 5%. AREVA considers that this reduction reflects the proactiveness of the operators in terms of safety, as the group’s demands in this respect are now widely known. As the group currently calls upon more than 280 transport suppliers (rail, road, sea, air, other services), their qualification is an important issue in itself. The information drawn from the audits and inspections was aggregated to produce a panel of 200 referenced suppliers and, in a selective logic, another panel of the most experienced suppliers.

Lastly, in AREVA’s opinion, outside the normal course of the activities, transport supervision includes emergency prevention and management: in a period of economic crisis more particularly, it would be illogical not to base the organisation’s response on resources which at other times are always dedicated to the collection and technical utilisation of sensitive information.

If necessary to prevent crises, and on the basis of the information obtained during analyses, on-site inspections and audits, the teams in charge of supervision issue technical recommendations to which the transport operators and AREVA sites must respond by improvement measures if they wish to receive or maintain a qualification, or to improve their level of control. Nearly 230 recommendations of this type have been issued since 2007.

In the event of a confirmed emergency, the supervision department within the Logistics Business Unit maintains control and coordinates the deployment of a PUI-T (Transport Emergency Response Plan). This implies, among other things, setting up a PCD (Command and Decision Post), a technical unit, a communication unit, and sending a mobile unit (equipped vehicle) and specialists to the site of the accident, to the customer and, if the event occurs in France, to the Prefect’s office concerned.

In the context of the international deployment of transport supervision, this response capacity is now reinforced by the TSAs and TAs (Transport Safety Advisors and Transport Advisors) located on all AREVA industrial sites. This means that a readily called-up resource and reliable information on the shipment will be available on site without delay.

This system as a whole is tested during company emergency exercises, some of which simulate accidents occurring outside France. In November 2010, for example, an exercise simulated an accident occurring in Germany (fictitious transport of maintenance tools in a contaminated reactor). It provided the opportunity to test the coordination of AREVA’s French and German entities. In France, other exercises periodically involve all the parties concerned (ASN, Prefects’ offices, decentralised State services, hospitals, media, etc.). They all provide the opportunity to test the responsiveness of the transport supervision system.

The shipments of radioactive materials are vital for AREVA: they maintain connections between the group’s facilities and its customers and suppliers across the

world. Even if the materials transported are dangerous, the transport operations must remain safe. The durability of AREVA's industrial model, based on the nuclear cycle, requires total mastery of all radioactive material transport movements, whether into or out of the group's sites. Hence the commitment to achieve the highest level of risk prevention at all stages of the logistic chain. This

commitment applies to all AREVA's logistics activities, whether carried out by the group, or subcontracted. Its corollary over the last 4 years is the deployment of a transport supervision system which, by maximising the safety of these activities, has given the group's Logistic Business Unit a real competitive advantage: safety is not only vital, it also pays. ■

The regulatory radiation protection requirements for radioactive material packages

The radiation protection of workers and the public during the transport of radioactive materials is a constant concern.

The general regulations relative to radiation protection provided for by the Public Health Code and by the Labour Code also apply the transport of radioactive materials as a nuclear activity in its own right: the public and non-specialised workers must not be exposed to a dose exceeding 1 mSv per year.

This limit is not however intended to constitute an authorisation to expose the public to up to 1 mSv: the regulations provide that any exposure, even low, must be both justified and optimised, that is to say minimised. These principles, applicable to any nuclear activity, are particularly applicable to the transport of radioactive materials.

The regulations contain specific requirements applicable to the transport of radioactive materials before a package is shipped.

Dose equivalent rate and surface contamination measurements must be taken. The limits specified in the regulations are.

- the radiation at the surface of the package must not exceed 2 mSv/h.
- the radiation at the surface of the vehicle must not exceed 2 mSv/h.
- the radiation at a distance of 2 metres from the vehicle must be less than 0.1 mSv/h.

In the case of exclusive use¹, these limits can be increased to 10 mSv/h in contact with the package on condition that the vehicle is equipped with an enclosure preventing the access of unauthorised persons, and that operations near the package are restricted (loading and unloading operations

between the start and end of shipment are prohibited).

- 4 Bq/cm² for surface contamination of the package for β , γ and low-toxicity α rays;
- 0.4 Bq/cm² for surface contamination of the package for the other α rays;

These limits are mean values applicable to any area of 300 cm² on any part of the surface of the package.

When designing a packing, a radiation protection analysis must be performed around the package design to demonstrate its conformity under the different transport conditions: routine (for all types of package), normal (for types pour IP-2, IP-3, A and B) and accident (for type B packages only).

For each transport condition, the regulations define tests corresponding to probable stresses and dose equivalent rates to be complied with further to these stresses:

- in routine transport conditions (mainly vibration stresses): the radiation at the surface of the package must not exceed 2 mSv/h.
- under normal transport conditions (minor incidents such as an object falling onto the package): no increase of more than 20% in the maximum radiation intensity on the surface of the package having undergone the regulatory tests;
- under accident conditions (major incidents such as a fire, a 9-metre fall): the radiation at a distance of 1 metre from the package must not exceed 10 mSv/h. ■

1. Exclusive use shall mean the sole use, by a single consignor, of a conveyance or of a large freight container, in respect of which all initial, intermediate and final loading and unloading is carried out in accordance with the directions of the consignor or consignee [TS-R 1].

The ASN system for informing the public about the transport of radioactive materials

Interview with Alain Delmestre, ASN Deputy Director-General and Director of Communication and Public Information

on asn.fr

■ **Movie on the transport of radioactive materials**



Making a documentary during inspection of a radioactive waste convoy in Valognes – November 2011

Contrôle : Alain Delmestre, is ASN regularly questioned on the transport of radioactive materials? Have the questions changed over the years?

Alain Delmestre : the transport of radioactive materials is a subject that is of great importance for the public opinion, because in the majority of cases the transport does not take place within the bounds of the basic nuclear installations but in public spaces. The moment radioactive materials are situated outside BNIs, public feelings run very high. The subject of transport therefore raises numerous questions and demands that can come directly from professionals as well as from the public, elected officials, and more generally opinion relayers such as associations and the press.

Questions can be divided into two categories: technical questions and topical questions relating to an incident or the organization of transport of vitrified waste such as the castor shipments between La Hague and Germany. The technical questions are usually highly precise, and concern in particular transport approvals, movement volumes and international regulations.

The topical questions are variable by nature as they are often associated with incidents. Whatever the case, they are always - and have been for a long time - given extensive press coverage. I remember in particular the very large turnout of journalists in 1998 when ASN presented the report requested by the Prime Minister on the radio-

logical impact of the contamination of rail convoys of spent fuel leaving EDF sites. The press conference was attended by no fewer than 60 journalists, which was quite rare for ASN at the time.

Much more recently, the Fukushima accident quite legitimately raised many questions linked to the fear of contamination of foodstuffs and materials imported by air or sea. And of course the castor convoys still trigger numerous questions when on the agenda. These convoys raise particularly high feelings due to their spectacular nature, the fact that they cross France, and the sensitivity of the issue in Germany.

How has ASN organised itself to inform the public and ensure a better understanding of the implications and the measures taken to ensure transport safety?

On the question of transport, as with all the areas relative to nuclear safety, we endeavour to address the subject as transparently as possible, by publishing the results of our inspections, providing information that helps the overall understanding of the question, and responding to each direct request.

With regard to reporting on ASN's action, since 2002, our web site at www.asn.fr has posted all the inspection follow-up letters and incident notices concerning the transport of radioactive materials, as well as the regulatory texts, and since 2008 the work of the Advisory Committee of Experts for Transport. In order to meet the demands of the professionals, we have published a set of guides intended to clarify the international regulations and their conditions of application in France, and to assist the notification of significant events.

ASN's public information and documentation centre receives the general public, answers its questions and places a series of publications on the subject at its disposal: regulatory texts, books, and reviews. The documentation centre personnel also respond to calls and e-mails on the basis of information provided by the competent ASN departments.

The *ASN Report on the State of Nuclear Safety and Radiation Protection in France*, the review *Contrôle*, and the *ASN Letter* provide regular reports on our action and current news on the transport of radioactive materials. We also endeavour to inform our institutional and associative partners at the HCTISN¹ and CLI² meetings, and at the annual CLI conference. And lastly, we respond to numerous questions from journalists. With this system, the whole of ASN is involved in developing the aids and content on the subject.



Why did ASN decide to deploy a special organisational arrangement for the transport of the Castor packages from 22-25 November 2011? What is the substance of the arrangement?

The spectacular nature of these convoys impacts public opinion, in particular because they travel on conventional SNCF railway lines, which brings the fear that a problem with the convoys could lead to an incident that has a direct or indirect impact on the public. We thus felt it was important to provide more detailed information on these convoys so that people can understand the conditions under which they travel and how the packings protect the radioactive materials, etc.

On complex subjects like this, ASN tries to facilitate the understanding of the implications by providing documents of a more educational nature at www.asn.fr, and making wide use of video and interactivity to supplement the regulatory texts and documents reporting on ASN's oversight actions. As nuclear transport is a sensitive subject, it is one of the first on which we wished to develop this principle.

Thus, some weeks before the convoy made its journey, we gave several journalists the opportunity to receive detailed information on the subject. We invited them to presentation meetings. We also suggested that they attend ASN's last pre-departure inspection of the convoy, which enabled them to understand the on-site technical organisation and observe the taking of measurements. This particular approach with the journalists in their role as relayers of opinion enabled them to be more precise in their articles and reporting assignments.

On the day of convoy departure, we inaugurated a completely original method by posting on www.asn.fr a detailed and illustrated information note along with an educational video in which Laurent Kueny, Director of Transport and Sources at ASN, explains the inspections carried out by ASN. We also posted on line a layman's scientific guide to the transport of radioactive materials in France, which describes the risks, principles, regulations, responsibilities and inspections. The Prefects and CLIs were sent a very detailed information note. Lastly, we invited representatives of the CLIs and associations to attend our inspections, and had the ACRO³ take complementary measures to those of the IRSN. There is nothing secret about these measurements - they are intended to protect the public and confirm the conformity of the packings. Having the radioactivity checked by ASN-approved associations with recognized technical skills provides added value for ASN in terms of technical weight and transparency.

This general approach of ASN, which aims at developing transparency while proposing aids to understanding was initiated in 2007, but it has clearly been stepped up and speeded up since the Fukushima accident. This accident effectively confirmed the need to inform the public, and also demonstrated the capacity of ASN to communicate on these subjects while taking the questions of security and industrial secrecy into consideration. The various players now help us in our approach by authorising us to film within their facilities. The publication of the reports submitted by the nuclear licensees in September 2011 in the framework of the complementary safety assessments

(CSA's) further to the Fukushima accident is another example of transparency.

What are the possible limits of public information on the specific question of radioactive material transport?

ASN tries to communicate in complete transparency while at the same time meeting the security requirements. A clear limit on this subject must be established with the other State players. In the area of transport, security is not overseen by ASN but by the HFDS⁴. Our remit therefore consists in ensuring transparency without jeopardising the security of the transport operations, and therefore in clearly delineating what can be said and what cannot be said, notably for reasons concerning the prevention of acts of terrorism.

In this context, ASN has set itself the task of explaining to the public what these transport operations involve, what the containers in question are, what guarantees they afford in terms of safety to ensure that no radioactivity can leak out of the packages. ASN does not however communicate on the routes taken, for example. The CADA (Committee of Access to Administrative Documents), after referral by ASN, expressed a clear opinion on the subject.

This opinion can be consulted on www.cada.fr/conseil-20114256,20114256.html

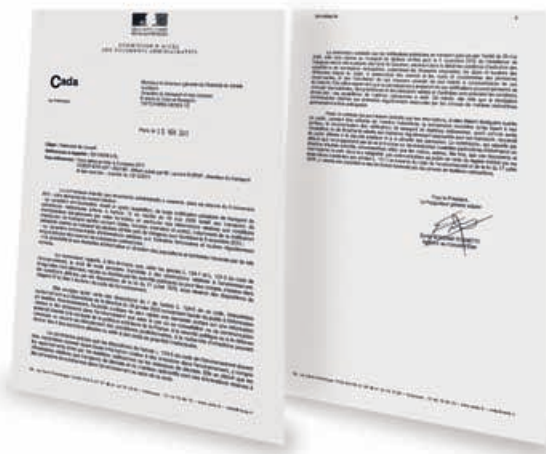

When it comes to security, there must be no "grey areas", that is to say everything that can be said must be said as simply, clearly and fully as possible. Conversely, everything that relates to security and which cannot be disclosed must not be disclosed at all. When it comes to these subjects, there can be no approximations or changes of position to suit the case; the public would find this difficult to understand and quite legitimately accuse ASN of misinformation. This position must of course then be explained, but I think that with repeated explanation it can be perfectly understood, and this is what we are endeavouring to achieve. ■

1. HCTISN : French High Committee for Transparency and Information on Nuclear Security (created by the 13 June 2006 Act).
2. CLI : Local Information Committee.
3. ACRO : Association for the Control of Radioactivity in West France.
4. HFDS : Defence and Security High Official.

The progress in law relating to public information in the area of the environment and nuclear activities

Article 2 of the act of 17 July 1978 guarantees any person the right to be communicated administrative documents. These are defined in article 1 of the same act as being the documents produced or simply held by a legal person governed by public or private law, who is responsible for managing a public service, from the moment the documents relate to the exercising of their public service duty (whatever the document support medium). The right to communication thus has a regulatory framework: it does not apply to uncompleted documents, or documents in preparation for an administrative decision, as long as that decision is still being developed, nor does it apply when the documents in question are publicly disseminated. Moreover, by virtue of article 6 of the act, administrative documents cannot be communicated if their consultation would infringe the secrecy of the decisions of the Government and Authorities that fall under the executive branch, national defence secrecy, French foreign policy, State security, public safety or the safety of persons, medical confidentiality and commercial and industrial secrecy.

The act of 2005, which in France sets out the obligations of the Aarhus convention that came into force on 6 October 2002, provides a more liberal system for "information relative to the environment" than the act of 1978. The act replaces the notion of document by that of "information (article L. 124-1 and subsequent). This means that the administration cannot, as was the case with the act of 1978, refuse to communicate on the grounds that no document exists: if a document does not exist, one must be produced in response to the information request. The need for preparatory work cannot be used as an excuse either. With regard to "emissions of substances into the environment", the cases in which communication refusal is provided for are also restricted to the rare cases where the communication could prejudice France's foreign policy, public safety or national defence, the performance of judicial procedures or the detection of infringements that can lead to criminal penalties, or lastly, intellectual property rights (art. L. 124-5). The secrecy of Government deliberations and industrial or commercial secrecy cannot be evoked. The environmental information held by ASN - the administrative Authority, or by the CEA - a public establishment of an industrial and commercial nature, can be communicated in the framework of these texts. Since

EDF and AREVA became public limited-liability companies, however, this administrative communication system no longer applies to them. The TSN Act however extends this system in the particular case of nuclear activities.

It is effectively within this category of "information relative to the environment" that the TSN act, which is now codified in the Environment Code, reserves a special status for information relative to nuclear risks. According to article 2 of the TSN Act, any person has the right to be informed by "the persons exercising nuclear activities" about the "risks associated with the nuclear activities and their impact on the health and safety of individuals and on the environment, and on the effluent discharges from the facilities". Paragraph 1 of article 19 institutes an information access right that has two characteristics:

- the information must be provided by the licensees of a BNI or, if the quantities exceed the thresholds provided for in the decree, by the entity responsible for a radioactive material shipment or the holder of such materials. For transport operations, a decree is currently being adopted to set the thresholds allowing application of article 19;
- they must relate to the "risks associated with exposure to the ionising radiation that can result" from the nuclear activity and to the "safety and radiation protection measures to prevent or reduce these risks or exposures". For example, the data concerning the general activity of the BNIs or the transport operations, which are not related to these risks, are therefore excluded from the system.

The big change introduced by the TSN Act is that the system of document communication instituted by its article 19 is applicable to both the administration and the nuclear licensees. The information requests can therefore be addressed directly to the nuclear licensees or transport supervisors. In the event of refusal to communicate, the disputes are brought before the administrative jurisdiction under the same conditions as provided for by the law of 17 July 1978. These legal changes represent a big step forward in the public's right to information concerning nuclear risks. ■

ASN calls upon ACRO's expertise for the convoy of vitrified waste packages shipped to Germany

Interview with Pierre Barbey, Vice-Chairman of Association for the Control of Radioactivity in West France (ACRO)

Contrôle : On 18 November 2011, ASN conducted an inspection at the Valognes rail terminal to check the conditions of shipping of the vitrified waste packages to Germany. For the first time ASN asked ACRO to carry out a radiological appraisal complementary to that of the IRSN, to back up the work of the inspectors, in the presence of observers from the La Hague CLI (local information committee). How would you sum up the results of this new pluralistic expert appraisal approach?

Pierre Barbey : the ACRO has been involved in various pluralistic expert appraisal processes since 1997 (North-Cotentin Radioecology Group, Uranium mine pluralistic expert appraisal group, etc.) initiated by the Ministry in charge of Ecology and/or ASN.

The case in point indeed represents, in our opinion, a new approach, as it is the first time our laboratory has been associated with an on-site ASN inspection as an independent expert capable of taking reliable radiological measurements and comparing them with those of the other players. Moreover, it was agreed that the ACRO would retain full freedom of expression once ASN had communicated on its inspection.

Over and beyond ASN's referral to ACRO, representatives of the AREVA CLI (including Greenpeace and the CGT) and an associative representative of the Paluel-Penly CLI were also invited to attend this pluralistic expert appraisal. This desire for enhanced transparency merits being underlined.

In the allotted time, the ACRO's limited appraisal focused on external exposure measurements. The details of these dose rate measurements are recorded in a technical note submitted to ASN on 21 November 2011, which can be consulted on our web site (www.acro.eu.org). It is noteworthy that the measurement results obtained by ACRO agree very closely with those of the IRSN.

The emitted radiation analysis constantly highlights a neutron flux about 2 times more intense than the gamma radiation flux (expressed in dose equivalent rate).

The total dose rates evaluated in contact with and at the centre of the waste package protective covers are about 130 $\mu\text{Sv/h}$. At a distance of 2 metres, the total measured dose rate is still 37 $\mu\text{Sv/h}$ (25 $\mu\text{Sv/h}$ for the neutrons and

12 $\mu\text{Sv/h}$ for the gamma rays). The radiation level is relatively similar from one wagon to the next.

Furthermore, some surface contamination checks made by ACRO at the extremity of a waste package gave negative results.

Granted, these values comply with the regulations relative to radioactive material transport – and notably the limit of 100 $\mu\text{Sv/h}$ at 2 m – but they are far from being harmless for as much, as these convoys travel and stop in places where members of the public can be present. For information, the natural ambient radiation values at ground level are respectively of about 0.08 $\mu\text{Sv/h}$ (gamma) and 0.01 $\mu\text{Sv/h}$ (neutrons). This means that 2 metres from a wagon, the exposure levels are respectively 150 times the background ambient gamma radiation level and 2500 times the background ambient neutron radiation level.

In addition to these regulatory measurements, ACRO took measurements perpendicular to 3 coupled wagons, at various distances up to thirty metres. At that considerable distance, the measurements are still clearly significant and extrapolation of these measurement points indicates that the radiation could be detectable at up to 60 m.

What measures could be taken to improve transparency in the area of transport? In your opinion, given the number of rail and road transport operations concerned, what form should public information take?

There is strong public demand for transparency in radioactive material transport, and this is perfectly understandable. Firstly because highly radioactive substances – as is the case with the vitrified waste – which are normally confined to protected nuclear sites, travel on the public highways or railways, passing through regions and near members of the public. Secondly because although licensees talk about transparency a lot, they are not at all inclined to practice it. We observed this in November 2010, when AREVA rejected the requests of associations that wanted to carry out independent inspections.

What upset us in particular in this “castors” affair was the lack of information given to the railwaymen who are in the front line and who, in particular, do not even have the possibility of knowing (in real or deferred time) what levels of exposure they are subjected to. At the request of some of their representatives, the ACRO approached the HCTISN on this question in December 2010.

It would therefore be advisable to renew the pluralistic approach involving independent laboratories such as ACRO in a complementary appraisal, along with the representatives of the CLIs concerned or stakeholders such as the railwaymen, in an ASN inspection or any other context. In this context, even if points of concordance can arise (on the measurements, for example), each player must be able to maintain its freedom of expression (particularly with regard to the interpretation of the data). For us there is no question of instilling distrust with respect to the IRSN under the pretext that it is the institutional expert, and even less to substitute for its own specific expertise. It is simply a question of contributing the view of an associative expert that adopts a position of citizen vigilance and whose independence and quality of expert appraisal is very widely acknowledged.

Lastly, such a pluralistic expert appraisal must not be understood or interpreted as a process aiming to reach a





consensus, even if, for example, results can demonstrate compliance with the regulatory values. It is simply a question of contributing to multi-source information that is as complete as possible so that each citizen can form his or her own opinion.

In short, it is a democratic requirement and achieving it necessitates a different form of teaching that stems more from the development of a critical mind than the will to reassure.

The desire for transparency must not be detrimental to the vital necessity for public safety and the prevention of malicious acts. How can these two notions be reconciled? Who has the legitimacy to make these arbitrations?

ACRO is a responsible association and we can obviously understand that certain data cannot be made public. And yet when it comes to nuclear activities, we have the feeling that ensuring security against malicious acts has too often been used as a pretext for classifying entire documents as “confidential” or “top secret”, when in reality only a few parts of them require this classification. In fact, knowing who applies the stamp and according to what criteria is always an impossible task. Although we can understand the “sensitivity” of plutonium shipments, we remain very sceptical about the similar qualification for the containers of highly radioactive ultimate waste weighing more than 116 tonnes.

Our association took part in the Transparency and Secrecy Working Group of the HCTISN, which produced

a report on these subjects in February 2011. Some proposals made by the HCTISN, even if they resulted from a desire for consensus, seem hardly relevant to us. More particularly, whereas the opinion of the CCSDN (Advisory Committee for National Defence Secrets) is only given in the framework of legal proceedings, the HCTISN proposes being a new entity authorized to bring cases on the appropriateness of declassification of nuclear-related information before the CCSDN.

Even if the HCTISN does not go this far, one could also imagine having recourse to a “third party guarantor”, a person or group of persons or entities recognised and tasked by all the stakeholders concerned to form an opinion on the complete version of the documents.

All this of course requires legislative modifications, but perhaps even more than this, significant changes in society and its representatives. ■

Inspection of a radioactive waste convoy in Valognes



Participation of the STOP-EPR group at ASN's inspection of the convoy of vitrified waste packages shipped to Germany

Interview with representatives of the “STOP EPR, ni à Penly ni ailleurs” group

Contrôle : During the ASN inspection at the Valognes rail terminal on 18 November 2011, you carried out a radiological appraisal complementary to that of the IRSN to back up the work of the inspectors. How would you sum up the results of this new pluralistic expert appraisal approach?

The “STOP-EPR ni à Penly ni ailleurs” group, which is also a member of the Paluel-Penly CLI (local information

committee), is very pleased that ASN was able to organise this joint inspection of radioactivity on a large convoy of radioactive materials. But in our rightful opinion, without the global nuclear catastrophe of Fukushima things would have been quite different. Last year, the public authorities refused a request from ACRO and Greenpeace to conduct inspections on the second-last convoy for Gorleben.

The anti-nuclear movement now has well-founded data

on which to establish the radiological impact of these convoys. Even if the overall radiation emitted by the “castors” remains within the limits permitted by the regulations in effect, it nevertheless remains high. Critical levels with regard to the thresholds of harmfulness recognised by the CIPR were measured in contact with the wagons by both the IRSN and ACRO. We are particularly sensitive to the neutron radiation that was measured. If what the IRSN says is true: *“When neutrons interact with the materials in the environment or living materials, they create, through nuclear interactions, diverse secondary particles which are the cause of deposits of energy in the tissues [...] Neutrons produce biological effects that are far more significant than X rays and/or are strongly dependent on their energy (factor of 5 to 20 depending on their energy).”* This subject raises major questions for us, as it does for SUD-Rail.

Consequently, we can but ask to what extent such a pluralistic expert appraisal approach can be implemented in the context of nuclear activities. Just how far can the industry and the Authorities representing the sector go when it comes to transparency and the questioning of their own decisions?

Involving the anti-nuclear movement in measurements and other observations is one thing, taking into consideration the criticisms we might formulate is something else.

Whereas in our point of view the challenge for nuclear safety is to reduce all artificial radioactivity that is harmful for man and the environment to zero, the industrial nuclear stakeholder has always been the prescriber of discharge standards. Adopting more stringent standards could lead to the cessation of nuclear transport activities and the shutdown of dangerous or poorly secured reactors.

What measures could be taken to improve transparency in the area of transport? In your opinion, given the number of rail and road transport operations concerned, what form should public information take?

Enhancing transparency would come down to granting us some degree of power where would be involved in taking decisions in terms of nuclear safety. Yet this is not at all the case, since our role is limited to information and observation through the CLIs. And only in this latter context, the only obvious procedure would be to inform the local authorities and help them implement truly efficient community safety plans.

According to the IRSN data for the year 2010, the evaluated collective dose for transport operations is 0.10 man.Sv for 1,118 workers monitored. This value is comparable with the collective dose for reprocessing. It is even two times higher if one considers the respective average doses (0.09 mSv compared with 0.04 mSv). For us, the conclusion is simple: the transport of radioactive materials is one of the major aberrations of the nuclear process. The reality of the observed doses clearly shows the harmfulness, even if infinitesimal, of these transport movements. Consequently, we demand nothing less than the cessation of these transport operations, the co-development of a new radioactive waste containment and storage doctrine, and above all a total reduction in the

production of such material for industrial purposes. It is indeed for this reason that for more than thirty years the anti-nuclear movement has been demanding the stoppage of the “reprocessing” strategy, the ultimate purpose of which is military, in the same way as we are today demanding the stoppage of the MOX process. The waste should be kept where it was produced. Stopping the transport of radioactive materials in our opinion is an effective and responsible way of reducing the exposure of the public, living and working areas, and the natural environments to nuclear risks, which are already too high in our country. It is above all the only effective solution for avoiding incidents, which are always a risk, as demonstrated on 13 October 2011 at Sotteville-les-Rouen for example, and above all accidents whose consequences could be both dramatically irreversible and humanly and societally unmanageable.

The desire for transparency must not be detrimental to the vital necessity for public safety and the prevention of malicious acts. How can, these two notions be reconciled? Who has the legitimacy to make these arbitrations?

Clearly, the French State was unable to reconcile the two notions during the last convoy of 23 November, when it unabashedly confused maintaining order and protecting a shipment by deploying means that greatly surprised the neighbouring populations give the actual extent of the public turnout, which Hervé Kempf describes so well in his blog.

Uncontestably in the eyes of any public force, if there was a disruptive element to remove from the peaceful gathering of 23 November, it was the convoy of nuclear waste on route for Gorleben, with its body of Swiss guards. Nuclear safety is one thing, demonstrating force is another, when it is not in reality an abuse of force. Last year, during a non-violent blockade, friends from GANVA (Group for Non-Violent Anti-Nuclear Actions) suffered injuries resulting from the inane violence of a French police force that clearly does not master the most basic intervention techniques for this type of blockade. The Government has once again decided to create a situation of insecurity to demonise an anti-nuclear movement which has only ever organised responsible acts of citizen resistance, whether in Plogoff or Valognes.

When all is said and done, the only true public safety measure is to stop transporting industrial radioactive materials, fuel or waste, by rail or by road. Prohibiting these highly sensitive transport movements would be a major guarantee against health and environmental risks. Prohibiting these transport movements would be an absolute guarantee against terrorist risks that no protection system can ever obviate; the ridiculous over-deployment of police forces seen from 23 to 25 November was still unable to prevent minor malicious acts. The disproportion in the means deployed to maintain order foreshadows the future exponential costs in the nuclear industry, faced with the constant and regular drop in renewable energies. ■



Security and safety: values that the SNCF Group shares

By Vanessa Bonvalot, expert in asbestos, chemical risks and ionising radiation in the Human Resources Department of SNCF, Didier Belleville, Transport Safety Advisor in the SNCF Freight Department, Patrice Rollinger, STSI Operations Director, SNCF GéoDis Group

Rail transport of radioactive materials takes place over the entire nuclear cycle. The nuclear power industry entrusts 500 shipments per year to SNCF GéoDis.

The cycle upstream of the reactor represents 80% of the transport activity. It notably involves shipments between the major French and European ports and the uranium transformation industrial plants, and transfers of uranium in different forms between these sites. We also ensure the carriage of fresh nuclear fuel elements for the EDF nuclear power plants (NPP).

Downstream of the reactor, we transport the spent fuel from the NPPs to the rail terminal of the La Hague reprocessing

plant. We also transport the spent fuel from various European countries to this same La Hague plant. At the end of the spent fuel reprocessing phase, we return the vitrified waste to the countries of origin. The transport activity of the downstream cycle accounts for 20% of the activity. We also transport the empty packings used in these transport operations.

Lastly, we also transport the very-low, low and intermediate-level waste to the ANDRA disposal sites.

The transport of radioactive materials is carried out in dedicated trains or by rail parcel delivery (Multi-Batch, Multi-Customer Service).



Loading a fresh fuel package onto a wagon

Security and safety: values that SNCF Géodis shares with the nuclear power industry players

The strong safety culture that is anchored within SNCF helped find and implement solutions to meet the safety and security requirements necessary for the radioactive materials transport activity.

We have more particularly developed radiological protection solutions adapted to the size of SNCF Géodis, its way of working as a network and its vocation as a general transport carrier. Furthermore, the security of shipments and compliance with the rules concerning the physical protection of consignments required the setting up of a specific organisation ranging from the conception of the transports to round-the-clock tracking of the shipments.

In addition, a continuous progress initiative has been put in place with the main nuclear power customers.

This organisation guarantees a high level of safety and security for the transport of radioactive materials by rail.

Radiation protection at the SNCF

The company has created a national skills network (national coordinator, hazardous materials transport safety advisor, and consultant occupational physician in radiological risks for the SNCF, national preventer in each activity concerned by the transport of radioactive materials), at regional level (hazardous materials transport - HMT- experts in each of the Freight entities concerned) and at local level (security representatives on the sites, occupational physicians in charge of the medical monitoring of the employees involved

in the radioactive materials transport process and local managers responsible for supervising these employees). The skills network checks compliance with the regulations in effect, assesses the workstation risks in the radioactive materials transport process, defines the prevention and protection measures in radiation protection, and develops the Radiological Protection Programme (PPR).

Where the transport of radioactive materials is concerned, the Regulations Concerning the International Carriage of Dangerous Goods by Rail (RID specify that it must be governed by a PPR. The PPR comprises a set of systematic provisions whose aim is to ensure that the radiological protection measures are duly taken into consideration. Any railway site open to the freight transport activity and likely to be involved in the transport of radioactive materials must therefore have a PPR that takes the local particularities into account. It is adapted according to the nature and type of material transported (fresh or spent fuel, uranyl nitrate, vitrified or low and intermediate-activity waste, etc.) and it is updated whenever necessary, notably in the event of traffic variations, a change in work organisation or the type of equipment, and whatever the case, at least once a year.

The PPR contains the following information:

- scope of application,
- optimisation,
- assessment of the radiological risks and the evaluation method,
- estimation of doses and dosimetric monitoring,
- evaluation of surface contamination,
- prevention measures,
- emergency actions,
- inspections,
- employee training,
- information given to the other employees,
- quality assurance,
- roles and responsibilities for the implementation of the PPR.

One of the provisions of the PPR consists in evaluating the risks at the workstation in accordance with the Labour Code, which serves to check that the employees are not exposed to an effective dose exceeding 1 mSv over twelve sliding months. To do this, SNCF used measurements taken by an IRSN-approved laboratory in transport situations and on all the types of radioactive materials transported. All the operations carried out near the wagons were detailed, allowing the theoretical annual exposure of the employees to be evaluated according to the frequency of the operations performed. The metrology and dosimetric monitoring have always confirmed that the 1 mSv threshold has never been exceeded to date.

Various prevention measures are recommended, particularly in terms of the protection perimeter, work organisation and operating procedures, training and information (transport document transport, placards-labels, activity documents

and check-lists) based on the ALARA (As Low As Reasonably Achievable) principle.

In the context of the PPR, any SNCF employee involved in the radioactive material transport process must receive training or information appropriate for the workstation, concerning the radiological risks and the precautions to take to restrict his/her exposure and that of other employees who could suffer the effects of his/her actions. The training is organised in two phases. The national preventers, the security representatives and the HMT experts are trained by an approved external body, the INSTN (National Institute of Nuclear Sciences and Techniques), for 3 days, with a refresher course lasting 1 and 1/2 days every 5 years. These people then give in-house training to the local managers who supervise the employees working in the radioactive material transport process, and the employees themselves. The other employees working near these shipments receive information via posters, distributed documentation or information meetings, in accordance with the RID regulations and the labour code.

Radiological inspection of the consignments

The RID obliges the consignors:

- to submit consignments whose surface contamination and equivalent dose values are less than or equal to the maximum permissible thresholds in transport situations.
- to declare these values before shipment by giving the carrier a DEMR (radioactive materials dispatch note).

Each DEMR is checked before the shipment is accepted.

Furthermore, with consignments of spent fuel and vitrified waste, each consignment undergoes an additional radiological inspection by an organisation independent of the consignor. The results of this inspection are sent to SNCF Géodis in addition to the DEMR. Each shipment is only

Rail convoy of spent fuel



authorised to travel after reception of these documents by Présence Fret, the body responsible for round-the-clock tracking of radioactive material shipments within Fret SNCF.

The wagons used for radioactive material transport operations are in principle reserved exclusively for these operations. They are the property of the loaders. A radiological inspection is carried out by the destination site after each transport movement, before the empty wagon is routed to another loading site.

The role of Présence Fret

Back in 1993, Fret SNCF created Présence Fret, an entity comprising employees specifically trained in the transport of dangerous goods, so as to have a team of professionals to serve the nuclear, oil and chemical industries, as well as respond to the expectations of the public authorities in the management of hazardous materials/radioactive materials in terms of real-time information.

Présence Fret is the "control tower" for the rail transport of radioactive materials within SNCF Géodis. Its role consists in providing a complete service covering all the operations inherent to the needs of radioactive material consignors and compliance with the regulations:

- taking charge of the order,
- establishing the carriage routing,
- production release and real-time tracking of consignments,
- informing those involved in the transport chain,
- contingency management.

The assignments attributed to this service are carried out in accordance with a clearly established process in a legal and regulated framework. Présence Fret receives an order from the authorised carrier, takes charge of it by establishing a prior notice (AP) adapted to the transported product category and describing the routing (stations passed through and times) of the wagon(s), routed as a dedicated constituted train set or individually in accordance with a transport plan scheduled according to the route taken. The prior notice, which also takes up the characteristics of the consignment, is sent to the persons and services concerned: consignor, consignee, authorised carrier, production services of Fret SNCF and of the delegated infrastructure manager, and the Authorities.

For shipments of spent fuel and vitrified waste, Présence Fret draws up a draft prior notice at D-3 and only issues the definitive AP after receiving the non-contamination certificate certifying the conformity of the convoy in accordance with the standards enacted by the RID. Issuance of this AP authorises consignment release for carriage.

Before leaving the dispatch, stopover, relay or border-crossing stations, the consignments are announced to Présence Fret and to the COGC (traffic management operations centre) concerned to confirm the incorporation of the wagon(s) in the planned carriage train. Présence Fret systematically inspects and verifies compliance with the carriage conditions communicated to the customer and, where applicable, to the Authorities, with the sending, stopover, relay and destination stations. Its operators regularly locate the position of the consignments thanks to the beacon equipping the traction unit of the train concerned.

In the event of noncompliance of the carriage, unscheduled stopping, or the taking of a diversion itinerary, Présence Fret acts as the interface between the internal players (Fret SNCF and SNCF Infra) and the external players (customer and Authorities) and establishes a new AP taking account of the modifications that create a new transport plan.

In the case of an event that could affect safety (called an MR event), Présence Fret – alerted by the COGC – immediately informs the consignor and the Authorities of the protective measures taken, then regularly informs them of the event handling developments.

In the case of events that could affect security (public order offences, demonstrations, etc.), the production services alert the local competent Authorities and Présence Fret, which ensures the forwarding the information in real time to the consignor and the competent Authorities.

In accordance with the Quality Assurance Plan (QAP), each deviation, nonconformity or event of any type is specifically analysed by Présence Fret, which implements corrective measures and an action plan to prevent recurrence of the observed malfunction. ■

FCC packages intended
for the transport of fresh fuel



The radiological protection programme

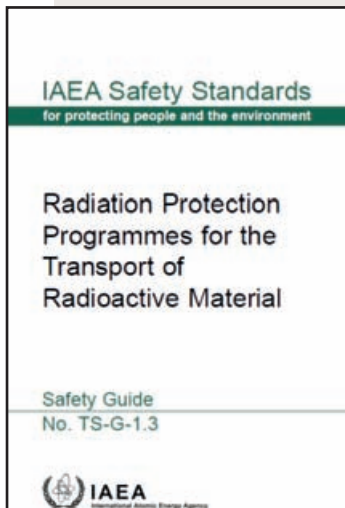

Since 1 July 2001 for air transport, and 1 January 2002 for the other modes of transport, all transport players must establish a radiological protection programme that integrates the measures taken to minimise human exposure. This programme must define the objectives in terms of radiation protection and describe the organisational setup and necessary resources to achieve these objectives.

The nature and scale of the measures implemented in a radiological protection programme must be commensurate with the levels and probability of radiation exposure. The regulations thus recommend workplace monitoring or individual monitoring of people working in transport from the moment the estimated effective dose received in one year is

between 1 and 6 mSv. Beyond this level (between 6 mSv and 20 mSv in one year), individual monitoring is required.

It is also recommended for the radiological protection programme to include an estimation of contamination, a description of the nature and frequency of the contamination inspections performed (inspection of work sites, packages and persons), and the radiation protection training provided. Training is effectively an underpinning aspect of the radiological protection programme. It is moreover provided for by the regulations, which oblige all the players in the transport chain to be trained and made aware of the nature of the risks associated with radiation so that they can reduce their personal exposure and that of others. Lastly, it is good practice to reiterate in the radiological protection program the measures taken for an emergency intervention, and their preparation.

The transport stakeholders can use the IAEA guide TS-G-1.3 as a guide to establish their radiological protection programme. These documents are regularly examined by the ASN inspectors during the radioactive material transport inspections. ■

The transport of radioactive material between France and Germany over the last 40 years

By Ulrich Alter, Federal Minister of the Environment, of Nature Protection and of Nuclear Safety - Germany

During the last 40 years, virtually all the existing types of radioactive materials have been transported between France and Germany (spent nuclear fuel, high-activity vitrified waste, plutonium, mixed oxide (MOX) fuel elements, uranium hexafluoride (natural, enriched, depleted), fresh nuclear fuel and various types of isotopes for medical and technical uses). Only one type of radioactive material has never crossed the border between France and Germany, and that is low- and intermediate-level radioactive waste. This is because for this type of radioactive material, disposal facilities and final storage receptacles exist in both countries.

As France and Germany are neighbouring countries, the predominant modes of transport are road and rail. Between 1972 and 2005, spent nuclear fuel transfers took place to honour the reprocessing contracts concluded between the German nuclear power plants (NPPs) and the AREVA NC reprocessing centre.

Delivery of spent nuclear fuel from the Germany NPPs to the reprocessing centre in France

At the end of March 2011, there were 17 NPPs in service in Germany.

Depending on the power of the reactors, 15 to 30 tonnes of heavy metals are unloaded each year from each reactor, which represents a total quantity of about 400 tonnes per year. The electricity producers are obliged to take measures to guarantee secure management of the spent nuclear fuel generated by their reactors. Between commissioning of the first nuclear reactor in 1966 and the end of 2010, a total of 13,470 tonnes of spent nuclear fuel had been produced. A large amount (5,309 tonnes) of this spent fuel was transferred to La Hague for reprocessing between 1973 and 2005, representing a total of 1,458 shipments.

The shipments were based on contracts concluded first in the late 1970's, and then again in 1990, by the German electricity producers and COGEMA and BNFL, for the reprocessing of spent nuclear fuel from the German NPPs. The contracts included clauses providing for the recovery of the radioactive waste and the separated plutonium.

Results of the reprocessing

The majority of the spent fuel has been and will be processed in France, and likewise, the majority of the separated plutonium will be produced in France.

With regard to the quantities of waste, a comparison of the two options, namely direct disposal or once-only reprocessing, reveals the following results:

- in the case of direct disposal, to the quantity of heat-generating waste to eliminate (in tHM¹) is identical to the quantity of spent nuclear fuel itself, that is to say 540 transport casks (Castor V/19);
- the reprocessing of 5,309 tHM of spent nuclear fuel nevertheless generates 108 transport casks filled with high- and intermediate-level heat-generating waste in the form of vitrified fission products.

The additional waste generated by the reprocessing of the spent nuclear fuel by AREVA NC represents 130 or at the most 160 transport and disposal casks for the non-heat-generating waste (low- and intermediate-level waste).

Vitrified waste transfers from France to Germany

The return of the vitrified waste from France to Germany is written into the contracts concluded between COGEMA / AREVA NC and the German electricity companies. These "reprocessing service contracts" provide for the return of the waste to Germany, in accordance with the commercial contractual obligations.

Once the nuclear fuel has been reprocessed, the majority of its radioactivity is confined in the fission products. These fission products are not reusable and are treated as high-level waste. During reprocessing, the fission products are vitrified and the final residues are sent back to Germany, their country of origin.

All the spent materials and operations carried out in the framework of these transport operations comply with the international (IAEA) and national legislation in effect. The disposal silos and transport casks are approved by the French Authorities (Ministries of Industry and of the Environment) and German Authorities (Radiation Protection Office, BfS). The disposal silos containing the vitrified residues are transported in a specific packing called a "transport cask". For the first shipment, which took place in May 1996, a TS 28 V transport cask was used, followed by the CASTOR HAW 28/20 CG and TN 85 transport casks.

MOX transfers

Deliveries of spent fuel to the La Hague reprocessing centre in France stopped on 1 July 2005. It will be ensured that for the remaining service life of the German NPPs, the recycled plutonium will be transformed into mixed oxide (MOX) fuels then irradiated in the existing NPPs in order to guarantee that the separated plutonium does not have to be disposed of in a receptacle. About 40 tHM of fissile plutonium will be separated by reprocessing of German spent fuel.

About 965 tHM of fresh MOX fuel has already been or will be manufactured from these 40 tHM of fissile plutonium. After reuse in one of the nine German NPPs that holds a regulatory license to use MOX fuel, the spent MOX fuel will be stored in one of the interim storage facilities pending its final disposal. The transfer of all the German separated plutonium by incorporation in MOX fuel should continue until 2013. The last batches of MOX fuel should complete their reactor cycle by 2019. When this is the case, all the separated plutonium will be incorporated in spent MOX fuel elements, in accordance with the American Department of Energy (DoE) standard on spent nuclear fuel.

Uranium hexafluoride transfers

Both Germany and France have uranium enrichment facilities. In one year, an enrichment facility with 4,500 tonnes of separative work units (SWU²) produces more than 7,000 tonnes of ore and up to 15,000 tonnes of residues (depleted uranium). Given the fact that there are no conversion facilities in service in Germany, the total quantity of residual depleted uranium produced in the enrichment centre may end up being transferred to a conversion centre in France. Since 2010, this type of transfer takes place between Germany and France every three months.

Transfers to Gorleben – a traditional target of the Germany anti-nuclear lobby

The spent nuclear fuel from the German NPPs is sent to France for reprocessing under contracts that oblige Germany to take back the reprocessed waste.

The first transfer of high-level vitrified waste between the reprocessing centre in France and the interim storage facility on the Gorleben site in Germany took place in 1996.

The last transfer of high-level vitrified waste was shipped from France to Germany in late November 2011. During this 15-year period, a total of 108 transport casks containing high-level vitrified waste arrived at the Gorleben interim storage facility.

And almost every year during the period when these transfers took place, various environmental defence groups hoped that demonstrating against these waste transfers would speed up the adoption of a bill on nuclear safety in Germany and force the country's NPPs to shut down more rapidly. The demonstrators and the police played cat and mouse while the train travelled on a secret itinerary through the heart of Germany to the Gorleben interim storage facility. ■

TABLE 1: NUMBER OF HIGH LEVEL VITRIFIED WASTE TRANSFERS

No.	DATE	NUMBER OF TRANSPORT CASKS PER TRANSFER	NUMBER OF TRANSPORT CASKS AT GORLEBEN
1	May 1996	1	1
2	Feb. 1997	2	3
3	March 2001	6	9
4	Nov. 2001	6	15
5	Nov. 2002	12	27
6	Nov. 2003	12	39
7	Nov. 2004	12	51
8	Nov. 2005	12	63
9	Nov. 2006	12	75
10	Nov. 2008	11	86
11	Nov. 2010	11	97
12	Nov. 2011	11	108

TABLE 2: QUANTITIES OF SPENT NUCLEAR FUEL INVOLVED IN THE REPROCESSING CONTRACTS CONCLUDED BETWEEN THE GERMAN OPERATORS AND THE COGEMA REPROCESSING CENTRES (FRANCE)

N°	NUCLEAR POWER PLANT	TOTAL WEIGHT OF SPENT FUEL [IN TONNES HM]
KKB	Brunsbüttel	295.6
KKK	Krümmel	237.9
KBR	Brokdorf	142.4
KKS	Stade	525.9
KKU	Unterweser	292.2
KWG	Grohnde	244.2
KWBA	Biblis A	406.1
KWBB	Biblis B	414.1
KWO	Obrigheim	207
KKP1	Philippsburg 1	380.5
KKP2	Philippsburg 2	209.4
GKN1	Neckarwestheim 1	322
KRBB	Gundremmingen B	187.6
KRBC	Gundremmingen C	105.8
KKI1	Isar 1	325.4
KKI2	Isar 2	179.2
KKG	Grafenrheinfeld	391.5
KWW	Würgassen	346.1
KMK	Mülheim-Kärlich	95.7
		5 309

TABLE 3: QUANTITIES OF SPENT NUCLEAR FUEL INVOLVED IN THE REPROCESSING CONTRACTS CONCLUDED WITH THE GERMAN NPPs (SPENT FUEL [TONNES HM])

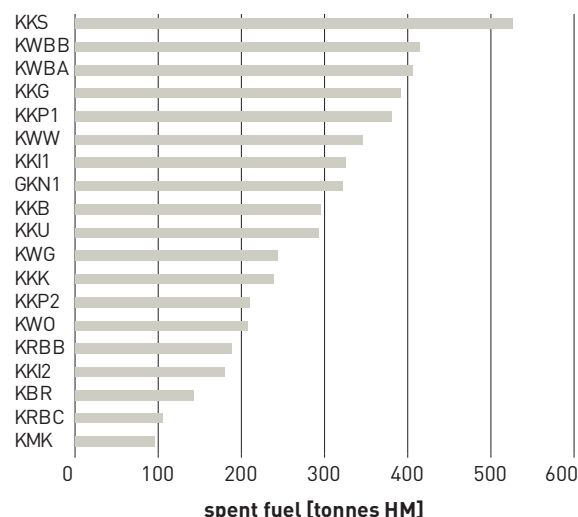

1. t_{HM} : tons heavy metal.

2. The separative work unit (SWU) represents the work necessary to separate one kilogramme of uranium into two batches of different isotopic content. The SWU is proportional to the quantity of material treated, and the energy necessary to obtain separation. It depends on the composition of the initial mix and the desired level of enrichment.

Study of the risks

associated with the extreme situations that can arise during the transport of radioactive materials

By Gilles Sert, Assistant to the Safety Appraisal Director, Institute for Radiation Protection and Nuclear Safety (IRSN)



A few months after the Fukushima accident, the scientific and technical community assessed the extreme accident situations that could affect nuclear activities in order to mitigate their consequences if ever they should occur, in spite of all the precautions taken. A similar approach could be envisaged for the transport of radioactive substances.

For some twenty years now, the IRSN has been interested in assessing the risks associated with accident circumstances not provided for by the regulations in force. In the context of experience feedback from actual accidents, the IRSN has conducted research programmes aiming to determine the safety limits of radioactive material packages, and recommend measures to protect the public in radiological emergency situations. In addition to this, extremely varied research topics such as the bogging down of a package in marshy ground, handling accidents in transit areas, long-duration fires and radiation protection deficiencies have been explored. This research generally enabled the adequacy of the regulatory requirements to be assessed, and in one case it resulted in the reinforcing of the regulations. It has also allowed the range of tools available to the

emergency teams in the event of a severe accident to be extended, and consolidated the skills of the IRSN engineers responsible for appraising the in-service safety of the packages.

This article presents the findings of this research work that could be used in a more general procedure for assessing and reducing the risks associated with radioactive material transport.

Mechanical risks

The regulations effectively define the mechanical tests the packages must undergo in order to simulate the accident conditions in which the package safety functions must be maintained. The most severe of these mechanical tests involve dropping the package from a height of 9 m onto an unyielding surface and, for low-weight packages, dropping a 500 kg steel plate onto the package from a height of 9 m, and dropping the package from a height of 1 m onto a rigid vertical steel bar, 15 cm in diameter. These tests represent an important step in the qualification of package designs.

Defined in the 1960's, the parameters of these tests do not fully guarantee that packages that are in conformity with their model would resist all the reasonably imaginable accident situations; nevertheless, the international community agrees on the fact that they should cover the large majority of plausible accidents. The fall - fortunately dampened - of a package onto a ship in 1991 rekindled the debate on the appropriateness of the regulations. To better convince itself of the robustness of the packages in true accident situations, the IRSN undertook a series of studies aiming at better understanding the behaviour of spent fuel and plutonium oxide packages in the event of impact with realistic items considered to be the most rigid found in their environment during normal transport movements.

The conclusion of these studies conducted over 10 years is that the design rules applicable to these packages gives

Package handling quay in Cherbourg harbour (Manche département)





Fère-Champenoise accident – April 2007

them greater rigidity than the objects that could threaten them in their normal environment; thus, a typical package designed to transport spent fuel could withstand a fall from a height of 9 m onto another identical package; the same package would be hardly affected by a fall onto its metal support frame or a wagon axle. The typical plutonium oxide transport package used for the study gave similar conclusions. Thus, in the majority of the assessed configurations, the package stresses are lower than those suffered during the regulatory free drop test from a height of 9 metres, which ensures satisfactory safety performance. This being said, the two package designs studied, with high potential hazards, do not claim to be a representative sample of all the existing package designs; extending this study to other designs, or at least to the designs that in principle are the least resistant, could be envisaged. Furthermore, a reflection could be undertaken to check that the studied collisions remain penalising for the conveyances and package handling means currently used. The impact of loads released accidentally above the packages themselves during handling could also be studied.

Thermal risks

The studies conducted by the IRSN to assess the thermal risks in transport accident situations beyond the design basis focused on three subjects: the consequences of getting bogged down, the behaviour of a uranium hexafluoride (UF₆) package in a fire, and more generally the behaviour of packages exposed to long-duration fires of varying temperatures.

Carried out jointly with manufacturers, and requiring the development of original calculation models, these studies enabled the safety margins available according to hazard severity to be specified for certain package models.

The first series of calculations concerned the bogging down of a spent fuel package in marshy terrain. On this type of terrain, the package could sink intact to the bottom of the marsh. The 1987 accident in Lailly-en-Val revealed the considerable amount of time necessary to recover a package of this type from soft ground. The safety implication in this case is to avoid letting the ground around the package dry out to prevent the risks associated with heating of the

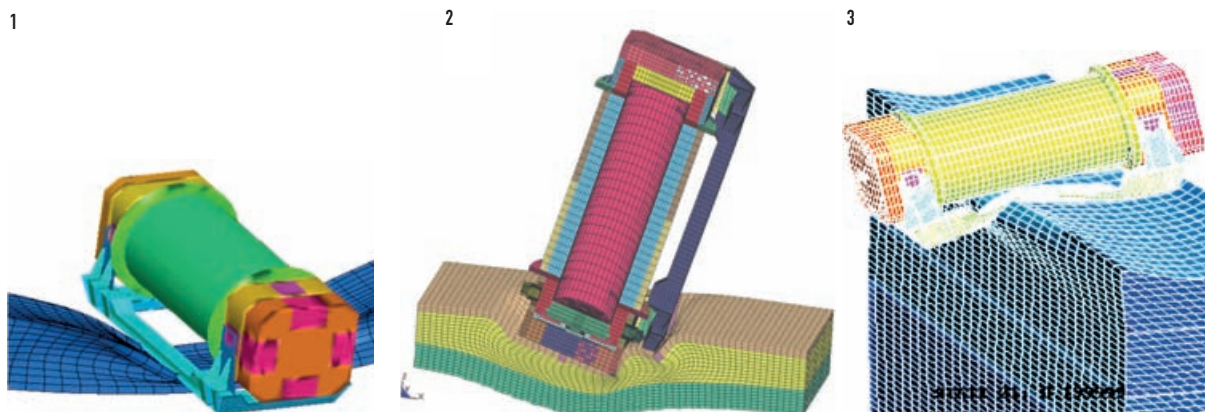

1. Package falls onto crane cross-bracing
2. Package falls onto concrete quay
3. Package falls onto side of ship

package seals on the one hand, and its spent fuel content on the other. The calculations have shown that a 100-tonne package whose content has a residual thermal power of 50 kW could remain without external cooling for at least 48 hours without fearing loss of its leak-tightness. Beyond this lapse of time it may be necessary to inject cold water around the package.

The second study programme focused on the characterisation of the behaviour of a container loaded with 12 tonnes of UF_6 exposed to a severe fire. In the event of leakage the risks would be associated with the radioactivity of the UF_6 and its toxic, corrosive and oxidising chemical properties. The reflections conducted after recovering the 30 containers containing a total of 350 tonnes of UF_6 from the holds of the Mont-Louis cargo ship that sank off the coast of Ostend in 1984 had highlighted the need to take the fire risk into account. The first experimental step based on oven tests provided better insight into the three-phase behaviour of the superheated UF_6 . A complex calculation model integrating in particular the hot creep behaviour of the container steel was then deduced from the ultimate burst tests. The collected data did not enable the risk of rupture of the containers to be excluded under the same conditions as those of the fire test codified in the regulations. Further to this, the regulations provide for this test to be taken into account in the design of the UF_6 containers. However, the need for thermal protection of these containers is not recognised in all countries, which complicates international transport.

The third program relating to the study of fires of varying severity and duration was initiated in the context of probabilistic studies of the risks associated with maritime transport. The fires that have occurred since then in a few large tunnels (the Channel, Mont-Blanc and Saint-Gothard tunnels) have confirmed the validity of this initiative. Fine-scale modelling of the behaviour of the fire-resistant materials that protect the packages, calibrated on an experimental characterisation, allowed a more accurate

Saint-Gothard
tunnel –
24 October 2001



determination of the fire exposure time that would risk causing the limit temperatures of the most fragile of the package components to be exceeded. The results of this programme not only confirmed the existence of significant margins with respect to the standardised test, but also provided charts allowing a rapid estimation – for example in a radiological emergency situation – of the risks of failure of the package sealing systems according to the estimated severity of the fire and its development time.

Radiation leakage risks

The packages incorporate shielding that greatly attenuates the radiation emitted by their radioactive content. To meet the need to more precisely know the radiation leakage intensity in the event of accidental loss of shielding integrity, parametric studies have been carried out for typical package designs. The event of December 2001 at Paris-Charles de Gaulle airport, further to which irradiation of the handling personnel was detected, confirmed this need. The IRSN now has, in its emergency preparedness aids, a tool that can estimate the damage caused to a package as a function of the dose rate increase that would be measured in a radiological emergency situation. This tool will be able to be used to obtain a more accurate diagnosis of the post-accident state of the package.

Calculation of the deformation and temperatures of a UF_6 cylinder exposed to fire

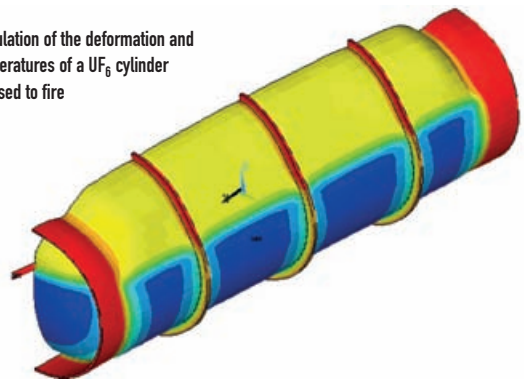

Conclusion

All the studies carried out for transport accident scenarios lying outside the area covered by the regulations have enabled the IRSN to develop skills and tools that are useful in radiological emergency situations; in some cases these studies have led to changes in the applicable regulations. Nevertheless, the transport situations studied do not pretend to cover all the possible risks. In this area it should therefore be up to those responsible for the utilisation of the packages to postulate the most severe accident scenarios among those considered possible, and to check that they can be managed; transport emergency management preparedness could thus be supplemented, even if great efforts are made in other respects to avoid these situations. ■

A necessary diversification of expertise: the role of the Advisory Committee of Experts for Transport

Interview with Jacques Aguilar, Chairman of the Advisory Committee of Experts for Transport¹

Contrôle : Mr Aguilar, why did you accept to take part in the work of the Advisory Committee of Experts for Transport (GPT), and to be its Chairman?

Jacques Aguilar : I have devoted most of my career first to the appraisal and then to the inspection of nuclear activities. I arrived at ASN (then DSIN²) on 1 January 2000, after working at the IRSN (then the IPSN³) from 1983 until that date, where I worked in a department responsible for fast-neutron reactors and experimental reactors, among other things. Before retiring on 1 April 2007, I was in charge of the ASN Industrial Activities and Transport Department.

The GPT⁴ was set up in December 1998, ASN being given responsibility for regulating the transport of radioactive materials in 1997. ASN created this advisory committee along the same lines as the one created for reactors at the end of the 1970's. From 1998 to 2007, the GPT was chaired by François Barthélemy, but as he was appointed ASN commissioner in 2006, he could not remain chairman of the advisory committee at the same time.

As the field is highly specialised, the number of potential candidates to succeed him was relatively small. As I was familiar with the functioning of both the ASN and the advisory committees of experts of which I was recorder, then member for several years, and as I now had time to spare, I proposed assuming the task, which the ASN Director-General accepted.

What are the professional profiles⁵ of the GPT members?

When ASN changed status in 2006, it decided to review the functioning of the advisory committees to guarantee the independence of its decisions. In the months following my appointment in 2007, the GPT continued functioning as before, with the renewal of the mandates of the participants for the time necessary to draw up the rules of procedure which were adopted in May 2008, and to select the new members who were appointed in September 2009 for a mandate that will end in May 2013. This change in functioning is not trivial. In the past, the



Jacques Aguilar during a meeting of the GPT

advisory committee was made up of representatives chosen by the licencees or applicants, but also by the administrations. With the new system the members are appointed individually, whatever their parent organisation. They must sit personally and cannot be represented by someone else. Moreover, the administrations are now invited, but are no longer members of the advisory committee.

Furthermore, to avoid conflicts of interest, each member has signed a letter of commitment whereby s/he declares "any current or recent participation in an activity (under contract or as a consultant, whether paid or not) for a company having a nuclear activity (in the broad sense)" and any "holding of a significant financial interest in a sector directly related to the area covered by the advisory committee". Each member has undertaken to inform the session chairman before each meeting, of any involvement, particularly contractual, that they may have with a question on the agenda. In such cases, the member in question does not participate in any of the advisory committee's votes.

The GPT comprises 23 people, including 3 foreign members, as ASN wished to open the advisory committees to its foreign counterparts. The foreign members of the GPT come from the British, Belgian and Swiss nuclear safety authorities. Other countries were given the opportunity, but the need to master French prevented their participation. Unfortunately, the GPT does not have a foreign equivalent, which would further improve the exchanges between our respective experts, complementing the work of the IAEA's TRANSSC⁶ and the relations that exist between ASN and the foreign Authorities.

The professional profiles of our members are very varied. We have specialists in transport and in all the related





areas: mechanics, thermal dynamics, criticality, radiation protection, etc. We have experts from the IRSN, people specialised in package design from the applicants, people responsible for package shipment or reception at the licensees (ANDRA, AREVA, CEA, EDF), carriers, including SNCF, and people specialised in the other risks (notably INERIS).

Can you summarise the advisory committee's opinion-making process, from the preparation of the work through to the discussions and drafting of the final opinion?

The GPT has met 5 times since 2007 at the request of the ASN Director-General, who wished to consult it⁷ on questions of package approval in particular. The complete process, between the moment the ASN Director brings the subject before the advisory committee and final decision making, spans about a year, with several intermediate steps during this period.

The process starts with a launch meeting between ASN and the IRSN after the applicant has submitted its file. It

continues with a kick-off meeting, this time in the presence of the applicant, who is there to answer the questions resulting from the preliminary appraisal conducted by the IRSN. Other questions from the IRSN are addressed to the applicant later on as the appraisal progresses. About a month before the advisory committee meets, a preparatory meeting is held between ASN, the IRSN and the applicant, to present all the IRSN's recommendations. This meeting is attended by the advisory committee chairman and the members who so wish. When the applicant agrees with the proposals, it takes them on as a written commitment, which reduces the number of recommendations detailed in the advisory committee meeting. At least one week before the date of the advisory committee meeting, the members receive the IRSN report containing its appraisal and its recommendations. They can also consult the complete file of the applicant. During the advisory committee meeting, the licensee presents its file, then the IRSN presents its appraisal and any commitments taken by the licensee, further to which the proposed recommendations are discussed. These recommendations can be modified, supplemented or even

Drop test of a new package design that will be appraised by the GPT in 2013

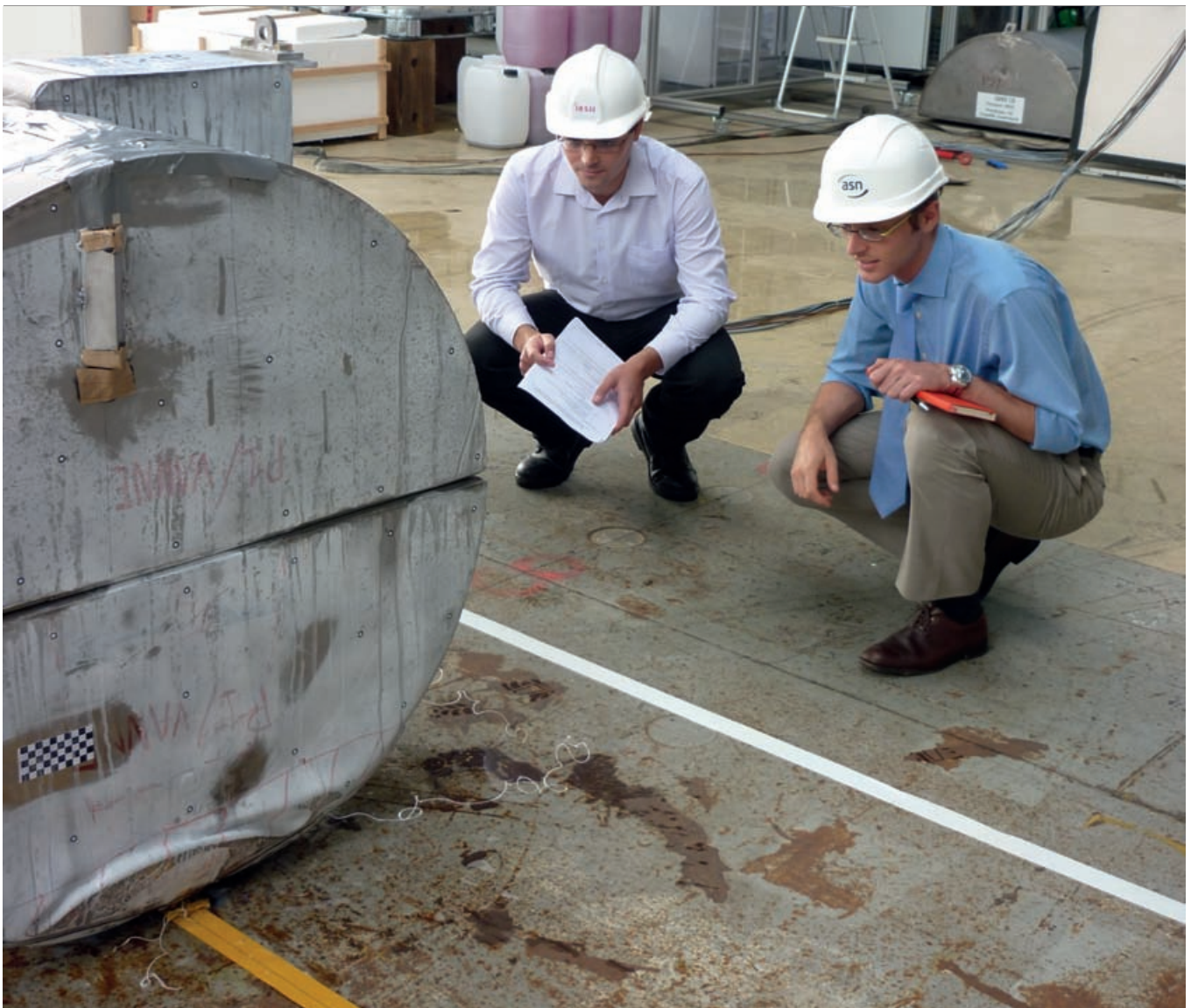

deleted in the advisory committee meeting. The meetings give rise to a written opinion in which the GPT expresses its judgment on the subject it has examined, and makes recommendations intended for ASN. On the basis of this information, ASN then delivers its decision which it makes public on its web site www.asn.fr. This publication includes the letter of referral, the opinion of the advisory committee, the position of ASN and a synthesis of the IRSN report. This transparency enables any professional or ordinary citizen to follow the work of the advisory committees.

How would you assess the work accomplished to date?

After two years of functioning, my assessment is positive with regard to the substance, but I have some reservations regarding the regularity of the meetings. Firstly, with regard to the substance, in my opinion we fulfil our assigned mission and give coherent and uniform opinions that help ASN take enlightened and serene decisions. We are concerned about keeping track of the subjects and treating them all in the same way - unless new knowledge or experience feedback should make us change our position - which guarantees the applicants impartial treatment.

In my opinion, the advisory committee's work consists in a second-level appraisal whose added value lies firstly in the sharing of information between all those involved who are concerned by the safety of transport of radioactive materials, and secondly in the transparency of the decision-making process.

This collegial way of functioning means that ASN and the IRSN are not the applicant's sole audience. The advisory committee members who form part of the transport chain as consignor, consignee or carrier, can also stand back from their specific work sector and acquire an overall view of the issues, get a grasp of ASN's requirements and understand the IRSN's recommendations. This provides

them with useful experience feedback for their activity or for the preparation of their future application files.

With regard to points to improve, we generally meet only once a year, whereas two or three meetings would in fact be necessary to address, in addition to the questions of package approval, the development of the regulations. This is an important point, because although the regulations are established at international level by the IAEA, via the TRANSSC, each country then ensures their application and can propose changes. The role of the GPT in this context would be to study the French proposals made by ASN, the IRSN or applicants, to "sort" them and then propose a consolidated list of the French proposals. Other subjects could very usefully be broached to help improve transport safety, such as the analysis of the lessons learned from incidents notified to ASN and from ASN's inspections, or the question of generic incidents. I have high hopes that in 2012 we will be able to set this new dynamic current into motion.

More generally, what do think of ASN's desire to use diversified appraisals?

It seems essential to me that ASN should be able to make its decisions independently by treating all the applicants the same way. To do this, it must be able to call upon pluralistic appraisals. This is a guarantee of independence and credibility for the applicants and public alike.

The question is finding the experts who have the necessary expertise to enlighten ASN. Some areas lend themselves better to this process than others. When it comes to transport, which is highly specialised, this seems relatively difficult.

Some specialists belonging to associations are members of advisory committees; in my opinion this approach is very interesting and useful for guaranteeing the plurality of views, the level of representation of the public, and thus enhancing the credibility and impartiality of the decisions taken. ■

1. The Advisory Committee of Experts for Transport (GPT) was created by decision of the ASN Chairman on 9 March 2007.

2. DSIN : Nuclear Installations Safety Division, which became DGSNR (General Directorate for Nuclear Safety and Radiation Protection) in 2002: ASN central structure until the November 2006 reform.

3. IPSN : Institute of Nuclear Protection and Safety, replaced by the IRSN in 2002.

4. The rules of procedure of the GPT approved on 4 June 2008 stipulate that "The role of the GPT is to enlighten ASN on questions relating to transport safety. To this end, it keeps itself informed of the progress of knowledge in the areas concerning safety, it contributes to the development of the safety doctrine and it responds to ASN's requests for opinions on specific subjects. It ensures the consistency of its positions in its various areas of action and on the different files it examines. It can propose the examination of certain subjects to ASN".

5. The rules of procedure of the GPT stipulate that "Several categories of participants take part in the GPT's activities:

- the members of the GPT who participate in all the activities,
- the guest experts who only participate in the meetings where an opinion is requested,
- the ASN representatives who participate in all the activities,
- the IRSN representatives who participate in all the activities,
- the representatives of the applicant, who only participate at the GPT meetings where an opinion concerning one of their files is requested, or if there is a general radioactive material transport safety issue that concerns them."

6. TRANSSC : TRANsport Safety Standards Committee (IAEA committee on radioactive material transport safety standards).

7. The rules of procedure of the GPT approved on 4 June 2008 stipulate that: "Three types of GPT consultations are provided for and give rise to meetings: consultations on draft regulatory texts; consultations on general problems of radioactive material transport safety; consultations on a file submitted to ASN by an applicant."

Moving towards a new consensus on the reference methods and parameters to use in the approvals of transport package designs

By Colette Clémenté, Assistant to the Director of Transport and Sources – Nuclear Safety Authority (ASN)



Joint inspection with the German Authorities before departure of the CASTOR
KNK – December 2010

On account of the duties conferred upon it by the Act of 13 June 2006 relative to transparency and security in the nuclear field (the TSN Act), ASN grants the authorisations or approvals and receives the declarations relative to the transport of radioactive materials (article 35).

To obtain an approval, the applicant must prepare a safety file demonstrating that the package design meets the regulatory requirements, and submit it to the safety Authorities concerned. To harmonise practices, the European Authorities - in the framework of the EACA (European Association of Competent Authorities for transport) - have produced a guide relative to the safety files for package designs intended for transporting radioactive materials (called the PDSR – Package Design Safety Reports

- guide¹). This guide is of major importance because all the European countries have undertaken to put it into application. Its scope is nevertheless limited to standardising the structure of the safety file, without addressing the safety requirements or the demonstration of package conformity with these requirements. This leaves the applicant a certain degree of flexibility. But the corollary is that practices are not uniform: additional demonstrations can be demanded by such and such an Authority when approval validation requests are made in a foreign country, and this can increase the examination times.

In 2009 ASN published a first guide for applicants, designed to facilitate the preparation of the approval applications and shipment approval requests for the transport of radioactive materials for civil uses. It includes the information concerning the safety file structure, the content of the draft



Petitioner's guide
(2012 Draft
Issue)

approval certificate, the minimum file examination times, experience feedback from the previous application examinations proposed by the IRSN, and the provisions in the event of modification of a package design or material. It is widely used today and is available on the ASN web site in French and English versions.

At the end of 2010, ASN decided to revise it for various reasons.

Some applicants asserted to ASN that it did not sufficiently master the examination processes in the area of transport with respect to the approval of new package models. Furthermore, the examination methods, based on continuous revising of the state of the art in terms of safety, in some cases do not provide sufficient visibility over the industrial lead-times. Lastly, ASN observed that in the past, many points of doctrine had been decided by issuing circular letters, which were now old, and that a definite benefit could be obtained – notably the conservation of the legacy of these doctrines and their improved readability – by grouping the content of these letters in a single document.

After wide consultation, the new version of the guide was published, integrating several new elements. One of them is the draft of baseline requirements concerning the safety requirements for the design of a package in accordance with the objectives set by the regulations. Effectively, even if the regulations stemming from Transport Safety Regulations TS-R-1 specify certain criteria, such as the need to maintain optimum containment of the package, they do not set gaseous mixture activity concentration values not to be exceeded for a package design, in transport operations under normal and accident conditions. These values can vary significantly depending on the chosen hypotheses (type of fuel - UO₂ or MOX), type of reactor (BWR or PWR), and each Authority defines its own reference value.

Elements of doctrine, reference methods and parameters judged acceptable by ASN in the context of safety demonstrations, are proposed in appendix 1 of the draft guide. This appendix constitutes a major change to the guide. It is intended to recapitulate the main requirements and safety standards that are used by ASN as references in the safety file examinations (values applicable for securing packages, rates of release of fission gases from spent fuels to be considered in the safety justifications, offset impact, etc.). This appendix is intended to be expanded at the now annual revision of the guide. The elements of doctrine gradually built up will be shared within the EACA with the aim of harmonising ASN's approach with that of its European counterparts. When the time comes, they will be able to be presented to the IAEA with a view to updating the regulations, document TS-R-1 or its application guide TS-G-1.1.

This guide should increase the quality of the examination process by giving applicants better visibility of the conditions of application of the safety requirements and their developments.

The second change concerns the examination process when a new package design approval application is made. The newly formalised process provides for stopping points (safety options file, test programme, safety file) between the applicant, ASN, and its technical support branch the IRSN, in order to identify as early as possible any shortcomings in the safety demonstrations that necessitate substantial additional inputs from the applicants, possibly even design changes.

The IAEA standards are an undisputed point of reference, and yet they do not set out all the requirements applicable to many players in the transport process. In these cases the requirements are defined at national level, giving rise to significant differences in approach from one country to another. In ASN's opinion, the applicant's guide must constitute a means of permanent dialogue between the various players, to gradually formalise the French approach to safety in the field of transport, over and beyond the regulations and the IAEA guides. The challenge is then to take this approach to international level so that it is gradually taken up in the regulations. One way forward for transport is that proposed by former IAEA director Mr El Baradei, who recommends, with regard to the guarantee of reactor safety, the international sharing of appraisals (Le Monde, 29 September 2011). The proposals of the ASN Commission Chairman presented in this issue of *Contrôle* fit into this context, by advocating a peer review obligation, which could be imposed at least at European level, to guarantee harmonisation of requirements so that safety progresses in all the countries of the European Union. ■

1. The PDSR guide can be downloaded from the following address:
www.asn.fr/Publications/Guides-pour-les-professionnels/Transport-de-matieres-radioactives

The inspection of package manufacture by ASN

By Claire Sauron, Inspector,
Transport and Sources Department -
Nuclear Safety Authority (ASN)

Transporting a shipment of radioactive material is the culmination of a long and demanding process involving the applicant, ASN, and its technical support branch, the IRSN.

This process starts even before the manufacture of the transport package, with the preparation of a safety file specific to the package, demonstrating that the package design complies with the applicable regulations. The safety file sets the objectives in terms of packaging design. It contains all the elements relative firstly to the requirements concerning the packaging and its content, and secondly the tests required to demonstrate the safety of the package design. It thus contains a thermal analysis, an evaluation of the radiation intensity, a nuclear criticality-safety study, test results, etc.

This file is examined by ASN with the assistance of the IRSN. ASN then delivers the certificate if it considers that the safety file demonstrates the safety of the package design.

The safety of a package during transport is based on the postulate that the packaging is strictly identical to the one described in the safety file. This implies that the package is manufactured in compliance with the design described, that it

Torn package
weld after a
drop test



is regularly maintained, and that the pre-shipment inspections are performed correctly.

A manufacturing defect could effectively jeopardise the safety of the package model and have serious consequences, something that was brought home to ASN inspectors during the examination of the safety file of a package designed to transport cylinders containing uranium hexafluoride. While the calculations demonstrated the mechanical resistance of the packaging to the drop tests, during the tests performed on a specimen (scale-1 mock-up), a weld failed, calling into question the resistance of the packaging in the event of fire.

The investigation that followed the tests showed that this difference between the theoretical calculations and the tests was caused by a manufacturing defect on the mock-up: the welding process required by the specifications had not been applied. The tests are therefore going to be repeated with a new mock-up, implying further costs and an extension of the examination process for the manufacturer.

The welding error occurred during the manufacture of the mock-up, but could have occurred during the manufacture of the package, thereby jeopardising its resistance in an accident situation. This example clearly illustrates the need for a rigorous inspection during the manufacture of the packages in order to avoid any deviations.

This inspection must be carried out first and foremost by the licensees. ASN for its part carries out sampling inspections during manufacture and maintenance to verify the conformity of the packages with the design described in the safety file.

To do this, ASN can use the regulations applicable to the transport of dangerous goods, which require the manufacturer to be capable of providing the competent Authority with all the elements for ensuring the conformity of packaging manufacture with the package design specifications approved by ASN. Moreover, the regulations indicate that "quality assurance programmes based on international, national or other standards that are acceptable to the competent Authority must be established and applied for the design, manufacture, testing, drafting of documents, etc."

During the manufacturing inspections of a package, ASN checks in particular that the design requirements of the safety file match the manufacturing specifications and the operating and inspection procedures. The quality assurance implemented and the conformity with the safety file specifications must be able to be demonstrated at each manufacturing step, and the following steps in particular:

- the procurement of materials conforming to the specifications (grade, mechanical characteristics, etc.) and their conditions of storage before use,
- the performance of compliant shaping and assembly procedures,
- compliance with the manufacturing steps, the stopping points and the in-process inspections,



– the detection and traceability of nonconformities, their processing and the analysis of their impact on the safety of the packaging,
 – if the manufacturer uses subcontractors, the role and responsibilities of each player.

In the last five years, ASN has inspected the manufacture of fifteen package designs for which an ASN-approval application had been made. These inspections concerned varied packages intended to contain fuel, waste, uranium hexafluoride, sources and effluents. All packages corresponding to new designs were inspected. The manufacture of older-design packages was subject to sampling inspection.

The number of inspections performed during package manufacture varies with the years according to the number of new packages manufactured, and must be associated with the maintenance inspections performed on existing packages.

These inspections reveal that the organisation and means implemented by the package designers and manufacturers are on the whole satisfactory and adapted to the safety issues and regulatory requirements. Several deviations have nevertheless been noted.

In the past, several of them concerned shortcomings:

- in the procurement of the materials: deficiencies in acceptance inspection traceability, non-exhaustive specification requirements, etc.,
- in the processing of nonconformity sheets: sheets not closed, failure to validate the analysis of the impact of nonconformities on safety, etc.,
- in the identification of the personnel training and/or qualification requirements,
- during modifications, in manufacture, with respect to the safety file: impact studies lacking or insufficient,
- in quality assurance.

Improvements in these areas have been observed with package manufacturers over the last few years, but quality assurance deficiencies are still detected during inspections. These mainly concern:

- deficiencies in the traceability of exchanges and formal validations between the package designer and manufacturer (non-compliance with stopping points for example),
- insufficient traceability of document updates,
- incomplete application of the internal quality baseline requirements (absence of supplier audits or internal audits).



Despite these deficiencies in traceability, in the light of the documents consulted and the discussions with the various contacts during the inspections, the inspectors generally noted that applicants were diligent in manufacturer monitoring, and that there were numerous exchanges between them.

As package manufacture is sometimes subcontracted to foreign companies, ASN occasionally visits foreign manufacturing sites to check the responsible manufacturer's tracking of the subcontracted manufacture. ASN thus visited a uranium hexafluoride cylinder manufacturing unit in Romania in 2011, and the TN 117 package manufacturing company in Italy in 2010. ASN was also invited to Belgium in 2010 to take part in an audit carried out by the Belgium competent Authority (AFCN).

The manufacturing inspections can also concern the manufacture of mock-ups that undergo the regulatory mechanical and thermal tests. As these mock-ups must be representative and therefore have the minimum characteristics required of the materials of the package to manufacture, their manufacture must be subject to the same rigour as the actual packages. ■

Left: verification of UF₆ cylinder weld during manufacturing inspection

Right: verification of thickness of materials used in shell manufacture

FIGURE 1: NUMBER OF MANUFACTURING INSPECTIONS PERFORMED BY ASN SINCE 2006

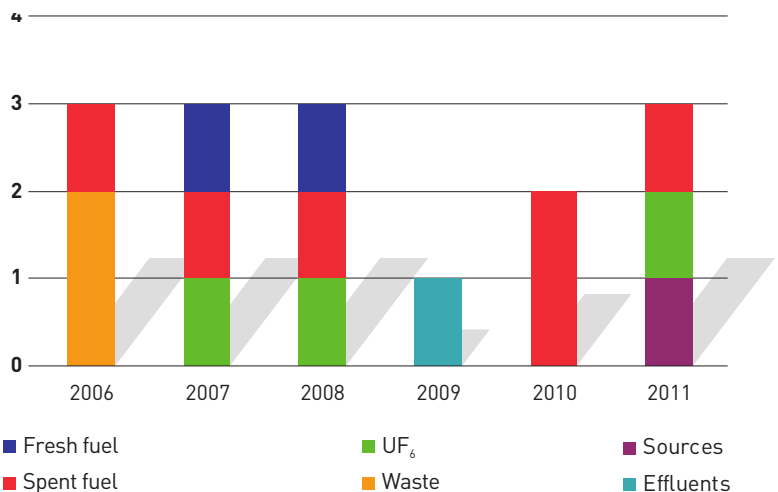

Designing and producing a package for the transport of radioactive materials

By Fabien Labergri, Technical Director - ROBATEL Industries



R72 package:
for transporting
spent fuel rods
for R&D
purposes

R adioactive material transport packages

The aim of a radioactive material transport package is to transport these materials while guaranteeing the safety of persons and the environment. To achieve this it must fulfil three principal safety functions: protection of people against ionising radiation, containment of the materials and maintaining of sub-criticality.

The effectiveness of these functions must be guaranteed whatever the transport conditions: normal or accident, with the configurations to adopt and the associated criteria being defined in the regulations. To ensure these main functions, a package must also integrate secondary functions. It must for example be sufficiently robust to withstand external mechanical hazards and stresses, such as the regulatory tests of puncture, crushing, stacking, free drops from a height of 9 metres, drops from a height of 1 metre onto a vertical rigid bar, immersion under 15 metres, or even 200 metres of water. It must be able to evacuate the residual power of the content, and also display good resistance to the fire test.

General design process

The first step in any design process consists in collecting the input data. In the case of a radioactive material transport package there are several types of data:

- the definition of the content;
- the constraints of the interfaces with the loading and unloading facilities;
- the transport constraints;
- the regulatory constraints (type of package, mode of transport, etc.);
- the industrial constraints (time, budget, etc.).

The design of the content often poses problems because often the content manufacturer does not consider and integrate the transport constraints. For example, the notions of heterogeneity, presence of radioactive gases (even in small quantities), the presence of potentially perforating elements (in the case of deconstruction waste, for example), etc., are often difficult to define in an overall manner.

The questions of transport are frequently forgotten in the early stages of design of production and reception facilities. This

ROBATEL: 50 years of package design

Founded in 1830, ROBATEL has been working in the nuclear sector for more than 50 years now. It is capable of offering its worldwide customers turnkey solutions integrating all the technical and operational elements of a project, from design through to production, qualification, delivery, on-site assembly and maintenance of equipment for the nuclear industry and nuclear research.

One of the specialities of ROBATEL Industries is the design and manufacture of radioactive material transport packages. Having launched itself into the adventure back in 1953, with the design of the first transport package in France (baptised “Zoé” after the first French nuclear reactor for which it was to transport the fuel), the company has observed and accompanied the establishment and development of this sector, not only in terms of regulatory safety requirements but also of technical solutions and innovation. Since Zoé’s time it has designed more than 70 type B packages and manufactured more than 500 units (all types considered). ■

results in high constraints on the package, in terms of weight, dimensions, radiation protection, etc.

The second design phase is the actual design of the package. Design starts with the internal fittings around the content (wedging, baskets, cases, etc.), then the various necessary functions are integrated: the containment chamber (thick steel envelope, elastomer or metal seals, etc.), the biological protections (superimposed layers of steel, lead and/or neutron-absorbing materials such as PNT7™ compound, etc.), the thermal protections (insulants, heating dissipating materials such as PNT3™ compound, etc.) and the mechanical protections (steel shielding and damping materials: wood, foam rubber, etc.). The design must also integrate all the functions necessary for the use of the package (such as the handling and securing means) while considering the other functional constraints such as weight and overall dimension with respect to the reception of the package on the facilities, or limitations induced by the means of transport used.

This is followed by the third design phase which involves producing all the demonstrations of package conformity with the regulatory requirements. The means of substantiation can include calculations and digital simulations (in all areas, such as mechanics, thermal dynamics, radiation protection, containment, radiolysis and criticality-safety) equally well as physical tests and experiments (drop tests, thermal tests, explosion tests, leak tests, material and process qualifications). It is also often necessary to support and corroborate these substantiations with experience feedback or even the implementation of specific research and development (R&D) programmes.

All the results are compiled and cross-referenced in a safety file to demonstrate compliance with the regulatory criteria and requirements. This file is then sent to ASN to support the approval application. ASN then calls upon technical experts, the IRSN and the GPT (Advisory Committee of Experts for Transport) in particular to appraise the safety file and the technical substantiations presented. ASN then decides whether to deliver the approval certificate or not on the basis of these appraisals.

The design process such as it has been presented up to here could appear to be a linear and well-sequenced process. In reality, the design of a package is a much more iterative and cyclic process. This is because the content definition, package design and safety analysis phases are obviously highly interdependent, and generally speaking the output data from one analysis constitute a portion of the input data for others. The final design of the package is therefore generally the convergence of many iterations and compromises.

Examples of problems encountered

We will present two examples to illustrate problems encountered during the design of a package:



Package model undergoing 9-m free drop test

Drop tests

The resistance of the package to the drop tests can be verified by calculation or by tests on a mock-up, which can be built on a smaller scale than the actual package.

The demonstration by test requires the defining of a mock-up that is representative of the package. Over the last ten years or so, designing such mock-ups has been increasingly complex with the increase in the level of demonstration required by the IRSN. This is because the demonstration must be deterministic. The demonstration of the representativeness of the mock-up must take into account all the manufacturing tolerances of the packages and the mock-up, the possible dispersal of the mechanical characteristics of the materials, the dispersal in bolt tightening torques, etc., with all these quantities being considered in a penalising and cumulative manner in the studies.

The main consequence of this type of approach is that the package cannot be designed independently of its mock-up, otherwise there is a risk of coming up against technical impossibilities in the production of the mock-up. One is effectively often obliged to oversize the package with respect to its probable behaviour (increase in the number of closing bolts, increase in the dimensions of the shock-absorbing casings, etc.) in order to make production of the mock-up possible. The tests, based on a test programme discussed at length with the IRSN, are then carried out on the ASN-approved facility at the Genas site.

The increase in computing power and the improvement of the finite-element calculation software for fast dynamics enables demonstration by calculation to be increasingly envisaged (see below). It does however have to be based on tests of similar packages in order to have a satisfactory qualification of the calculation model. Here too the deterministic approach can lead to a very large number of calculations to study the influence of different parameters (drop angle, temperatures, manufacturing tolerances, numerical parameters, etc.).

Whatever the case, ROBATEL Industries benefits from its considerable experience in terms of drop tests (more than 10 test campaigns since 2001, and several dozen prior to this).

System of securing the package on the conveyance (means of transport)

It is interesting to consider the question of securing, because it illustrates the problem of the interpretation of the regulations: the regulations do not provide any figures for the

securing stresses that must be allowed for. In the associated guide, acceleration values are indicated, but they are not unanimously agreed upon internationally, or even nationally. This lack of clarity and consensus of opinion poses a real problem for the designers, because it means that their design choices can be called into question at any time. Yet the defining of the securing system is a very important point in the design of a package. Here too it is a question of compromise: the overdimensioning of the system can be detrimental to safety during the drop tests in particular, as the securing components and frame, which are extremely rigid, could damage the package.

Conclusion

The design and manufacture of a new package design (of type B) through to its approval is a long process (3 to 5 years). It requires an overall and multidisciplinary view to integrate all the interdependent constraints.

Even if the regulations (from the designer's point of view) have changed little since 1976, the level of substantiation required to obtain an approval in France has considerably increased over the last ten years. This rapid change poses problems from an industrial standpoint, particularly in terms of control of costs and lead times, and the durability of the packages (as an approval is only valid for five years at the most, obtaining an extension can become difficult if further substantiations are required, such as the calling into question of the previously performed drop tests).

ROBATEL Industries has been developing new radioactive material transport package designs since the activity began, and is therefore perfectly informed of the required level of substantiation, which is a considerable asset for the success of a project.

Certainly the increase in the level of substantiation leads to an increase in the safety margins with respect to the transport regulations, but beyond a certain limit it can also have negative consequences on overall safety. It can effectively lead to an increase in the number of transport movements (further to a reduction in loading) and therefore in the risk of accidents occurring, and an increase in operating times (and therefore personnel exposure to radiation).

Furthermore, the level of safety is bounded by the transport regulations, whereas the level of substantiation of compliance with the regulations, based on a 100% deterministic approach, is not. Beyond a given level of substantiation, the effort required to increase it is considerable, whereas the corresponding increase in safety is small. One could in this case talk of a "reasonable" level of substantiation, echoing the now famous ALARA (as low as reasonably achievable) principle.

It is therefore important for ASN to take a stance on the required level of substantiation and the acceptable safety hypotheses and margins.

Package designers such as ROBATEL Industries, thanks to their expertise and experience, can help ASN determine this stance, particularly in generic subject matters that are poorly defined in the regulations. ■

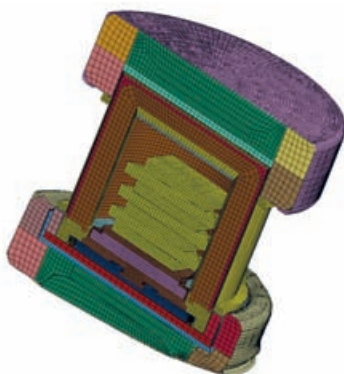

Rapid dynamics calculation (R73)

On-site transport movements in secret basic nuclear installations

By Emmanuel Jacob, Special Advisor –
Defence Nuclear Safety Authority (ASND)

Requirements set by a DSND directive

Each secret basic nuclear installation (SBNI) must have on-site transport rules governing the organisation and management of on-site shipments of dangerous goods for which it is responsible. These rules must guarantee a satisfactory level of safety of on-site transport movements with respect to the level of safety applicable on the public highway, with package performance being able to be adjusted to take account of the specific characteristics of the site on which the packages will be transported.

In the context of a DSND directive, the on-site transport rules are established by the licensee as a stand-alone manual specifying in particular:

- the organisation, responsibilities and quality assurance rules;
- the types of package and transport systems where applicable (package associated with a conveyance);
- the conditions of transport;
- the management of anomalies and emergency situations.

The on-site transport operations are carried out:

- either under conditions that comply with the regulatory requirements applicable on the public highway;
- or with packages or transport systems complying with a design approved by the director of the site in charge of the SBNI or by the DSND, depending on the quantities of material transported;
- or under the cover of a special arrangement shipment approval certificate delivered by the DSND, when additional measures turn out to be necessary (reduced speed, escorting of the convoy, etc.).

The on-site transport rules are subject to the approval of the DSND, as is any subsequent modification affecting the organisation or safety. The DSND can make its approval conditional to requirements or recommendations.

A DSND directive sets the framework applicable to on-site transport movements in the SBNIs. The rules developed accordingly, for which prime responsibility lies with the licensee, are approved by the DSND. Authorisations relative to package models are delivered by the site director or by the DSND, applying a progressive approach according to the characteristics of the transported contents (maximum activity, fissile nature, author dangerous properties, etc.).

The DSND

The nuclear safety and radiation protection delegate for nuclear facilities and activities concerning defence (DSND) exercises the functions provided for in articles R.*1412-1 to R.*1412-4 of the Defence Code. The delegate is responsible for studying and proposing to the Minister of Defence and the Minister for Industry, the nuclear safety and radiation protection policy applicable to the nuclear facilities and activities mentioned in the article R.*1333-37 of the Defence Code, particularly the secret basic nuclear installations (SBNI), and any adaptations to the regulations s/he deems necessary. S/He checks its application.

With regard to transport operations associated with the nuclear weapons and naval nuclear propulsion, the DSND is the competent Authority within the meaning of the hazardous materials transport regulations. As such, s/he delivers the shipment approvals necessary for the carriage of the packages. These authorisations guarantee a satisfactory level of shipment safety from the viewpoint of the international standards (IAEA transport regulations TS-R-1, the European Agreement concerning the International Carriage of Dangerous Goods by Road, etc.).

Regulatory framework applicable to on-site transport in the SBNIs

An SBNI usually comprises several individual facilities and dedicated traffic lanes. The notion of on-site transport, within a closed perimeter, is clearly defined for an SBNI.

According to the terms of Directive 2008/68/CE of the European Parliament and of the Council dated 24 September 2008, taken up by the order of 29 May 2009 relative to the land transport of dangerous goods, the European Agreement concerning the International Carriage of Dangerous Goods by Road is not applicable to transport operations carried out entirely within a closed perimeter.

Consequently a DSND directive sets the regulatory framework applicable to on-site transport movements in the SBNIs. This directive aims at ensuring consistency for on-site transport movements by covering all the individual facilities and the traffic lanes. ■



■ ■ ■ The tests that the packages to approve must undergo can be adapted according to the site characteristics and the available means of intervention. Moreover, it is possible to approve an on-site transport system (package associated with a dedicated conveyance; if necessary, safety functions can be carried over to the conveyance).

With regard to the traffic lanes, preference should be given to lanes that enable a potential hazard risk for the facilities to be avoided in the event of a dangerous goods transport accident. Whatever the case, the baseline safety requirements of the facilities must be consistent with the consideration of this risk. Furthermore, it is necessary to control simultaneous operations, particularly during the crossing of vehicles loaded with dangerous goods, taking into

account both the on-site and off-site transport movements (departure from or arrival at the site).

Finally, the safety of on-site shipments must be examined from an overall on-site approach, taking into account radiation protection, the traffic lanes and the interfaces with the facilities. Stability of the requirements would seem fundamental, in order to establish the licensee in a long-term process of continuous progress.

Lastly, particular attention must be paid to the on-site transport rules applicable on mixed sites (joint presence of SBNI and BNIs), in the context of the BNI order which could change current practices as regards civil installations. Harmonisation of the requirements between the nuclear safety Authorities must be favoured. ■

On-site transport rules for a SBNI operated by the CEA (Alternative Energies and Atomic Energy Commission)

The Advisory Committee of Experts responsible for Transport and the Transport Safety Commission, under the aegis of ASN and DSND respectively, met jointly in 2001 to examine the general rules of on-site transport developed by the CEA. Further to the resulting recommendations, the CEA's on-site transport rules were amended then implemented on each site.

General principles were consolidated on this occasion, notably the organisational arrangements and the requirements relative to the transported materials and the packages. The tests representative of transport accident conditions on the public highway were adapted to the sites, taking into account the speeds of travel and the means of intervention. For example, a drop test from a height of 2.5 m onto an unyielding surface combined with a thermal test at 800°C for 15 minutes, were adopted.

As of 2001, the setting up of a transport office in each CEA centre enabled operational skills to be acquired and developed. The centre's transport office provides technical assistance to the head of the facility: it establishes its appraisal of the material-package match, and ensures the availability of packages that are properly maintained and in conformity with the baseline safety requirements. Furthermore, a package design authorisation system has been established, involving either the head of the site (centre director, head of a facility), or the nuclear safety Authority (ASND for the

SBNIs, ASN for the BNIs) according to their use in on-site transport and the nature of the transported content.

In this context, the transport package pool has noticeably evolved over the years. The concepts have been streamlined and upgraded, reducing the number of designs used on each site. This approach is propitious to better control over the package pool and the associated transport operations, while at the same time aiming to obtain longer transport authorisations.

What is nevertheless brought out is the need to adapt certain requirements according to the facility operating constraints, particularly for end-of-life facilities which can no longer be modified. The typology of the identified risks enables additional substantiations associated with the conditions of use of these packages to be developed, in order to guarantee a satisfactory level of safety.

Finally, the development and operational implementation of on-site transport rules necessitate substantial work and investments, particularly for the creation of new package designs. The finalising of a new concept, often complex, requires developments spanning around five years. In this context, the stability of the regulatory requirements is vital. ■

On-site transport operations on the nuclear sites

By Claire Sauron, Inspector, Transport and Sources Department - Nuclear Safety Authority (ASN)



Private roads on the Tricastin site

The utilisation of hazardous materials implies moving them around within a nuclear site. Today, the transport operations called “on-site transport operations” are not subject to the regulations governing the transport of dangerous goods (ADR), which only apply on public highways.

On-site radioactive material transport operations are currently organised on several nuclear sites by “internal transport rules” that have been communicated to ASN. These rules, based on the planned approach for the public highway regulations, provide for ASN “authorisations” beyond certain thresholds (activity, presence of fissile materials, presence of UF₆, etc.). These rules specify the package design requirements that are adapted to the risks present on the site and the means of intervention. For example, the rules provide that the immersion test that type B packages for use on the public highway must undergo is not mandatory for a package model that does not leave the site, if it is demonstrated that the itinerary does not pass near any area of water, including in the event of loss of control of the vehicle. Similarly, the 30-minute fire test can be shortened if it is demonstrated that the local safety organisation can intervene in less than 30 minutes.

However, some French nuclear sites do not yet have on-site transport rules, as they are not required by any regulations.

ASN has just given a legal basis to the regulation of on-site transport by integrating it in the new technical regulations relative to basic nuclear installations (more commonly called the “BNI order” of 7 February 2012).

The reason for this is that on-site transport of hazardous materials presents the same risks and inconveniences for the environment and the public as the transport of dangerous goods on the public highway. When these operations are carried out within the BNI perimeter, their safety must be overseen on the same account as the other risks and inconveniences present within this perimeter. It is therefore logical that the framework for on-site transport operations

should be the same as that for all the operating operations carried out within the BNI perimeter.

The principles adopted in the new technical regulations of the “BNI order” are as follows:

- if on-site transport operations comply with the regulations relative to the transport of dangerous goods on the public highway, then they are considered to have a satisfactory level of safety and can be carried out on the private roads of a site;
- if on-site transport operations do not comply with the regulations relative to the transport of dangerous goods on the public highway, their level of safety must be analysed and demonstrated.

Under these new regulations, the BNI licensees will have to declare all the types of on-site transport operation they wish to carry out, and their corresponding operational provisions. All dangerous goods will be concerned (radioactive materials, inflammable liquids, corrosive substances, etc.). The aim is to ensure that all on-site transport operations attain an acceptable level of safety.

These demonstrations will have to be integrated in the safety reports of the BNIs concerned by these on-site transport operations. As for the operational provisions for the performance of these operations, they will have to be described in the general operating rules (RGE) or the general surveillance and maintenance rules (RGSE) for the installations undergoing decommissioning.

The technical regulations applicable to the basic nuclear installations shall govern the requirements for the transport of radioactive materials and hazardous materials (hydrazine, hydrogen fluoride, inflammable liquids, etc.) within the perimeter of the BNIs. Several installations with different legal statuses can nevertheless coexist on a given nuclear site: BNIs, SBNIs, ICPEs (installations classified on environmental protection grounds). Consequently, a consistent approach in terms of risk prevention and management in the event of incidents is necessary between Authorities, and particularly with the ASND. ■

Co-operation between UK and French Competent Authorities on the Regulation of the Safe Transport of Radioactive Materials

By George Sallit, deputy chief inspector, Radioactive Material Transport Department – Office for Nuclear Regulation (ONR), Grande-Bretagne

About 20 million consignments of radioactive material (which may be either a single package or a number of packages sent from one location to another) take place around the world each year. In Europe, 11 million packages are transported each year with 500,000 in the UK and 900,000 in France. In the many tens of years that these materials have been transported there has not been an incident where there was any harm to the workers, the public or the environment from these transport operations. An excellent safety record.

Since 1961, the International Atomic Energy Agency has published the international regulations for the safe transport of radioactive materials. These regulations have been widely adopted throughout the world and give a common set of requirements for each country to allow the free transport of radioactive materials. In Europe, the transport of radioactive materials is regulated through a European Directive and the ADR and RID regulations for the transport of radioactive material by road and by rail. These regulations require consignors of significant quantities of radioactive material to provide a safety report to their Competent Authorities showing that they have met all the regulations. This safety report is examined by the Competent Authority and if it meets the regulatory requirements then a Certificate of Approval is issued by the Competent Authority.

In February 2006, the Competent Authorities of France and the United Kingdom introduced a mutual recognition scheme. In this scheme, if one country analyses a safety report for a package and finds it meets the requirements of the regulations then they would issue a Certificate of Approval. The other country would then accept that analysis and issue a Certificate of Approval for their country. At the time, this was a big step for each country as the UK and France had slightly different ways of demonstrating compliance with the regulations although both countries used the same European regulations. Both countries have very high quality staff with recognised international expertise in the transport of radioactive materials. Both countries' arrangements have been critically analysed by IAEA TRANSAS¹ missions that showed both Competent Authorities had excellent ways of working using high quality people. Both regulators therefore

recognised each other's expertise. In addition, it was agreed that both Competent Authorities would meet every six months and talk about the safety reports they had analysed. Both regulators also talk about their latest work and research to ensure that their standards remain modern and consistent.

Since the signing of the Memorandum of Understanding, over 50 packages have gone through the mutual recognition scheme and as a result, the understanding between these two groups of experts has improved. The consignors of these packages have said it now takes much less time to get Certificates of Approval from both Competent Authorities and allows greater flexibility in these transport operations.

Because of this success, the MoU was expanded in 2008 and the UK and France now co-operate across all issues on the safe transport of radioactive materials and not just safety reports for package assessments.

This model has worked so well that a new initiative was launched in 2007 to increase co-operation between all European Competent Authorities with the formation of the European Association of Competent Authorities. This initiative increased co-operation on a range of radioactive transport safety issues and has helped to better harmonise the implementation of the European transport regulations. The European Association of Competent Authorities now has over 22 countries as members and is a good basis for further co-operation within Europe. It is also a good platform for the European voice to be heard.

We look forward to further co-operation and better integration for the regulations covering the transport of radioactive materials throughout Europe.

We would also like to consider whether a similar arrangement could be adopted throughout the world as most countries are already following the IAEA transport regulations. ■

1. TRANSAS : TRANsport Safety Appraisal Service.

Inspections and sanctions in Belgium

By Guy Lourtie, Head of the Import & Transport Department- AFCN (Federal Agency for Nuclear Control), Belgium



Each year some 400,000 packages of radioactive materials are transported in Belgium. This represents about 40,000 shipments per year. The medical sector accounts for the majority of these movements, with 350,000 packages transported in 35,000 transport operations between the various Belgian and foreign production centres, Belgian hospitals, universities, Zaventem and Liège airports, etc.

30,000 packages, i.e. 3,000 shipments are for industrial, agronomic or research applications. Lastly, the nuclear sector represents about 20,000 packages, or 2,000 shipments.

Inspections by the AFCN inspectors

The Federal Agency for Nuclear Control (AFCN) is tasked with overseeing and ensuring compliance with the national and international regulations, chiefly the modal regulations applicable to the transport of hazardous materials in class 7 – radioactive materials.

In the framework of the AFCN's inspection programme, its inspectors carry out inspections in the field, whether during specific transport operations, targeted actions in

collaboration with the police, or at important loading, unloading or transshipment points.

The AFCN aims at a preventive rather than repressive approach in the radioactive material transport sector. Consequently, in addition to its checks and inspections, the AFCN organises conformity audits with all the players in the radioactive material transport chain, and regular contact meetings with the carriers and consignors.

Table 1 shows the number of inspections per type of conveyance for each year since 2008, indicating the number of conveyances for which infringements were observed.

It is also important to examine the types of infringement. Figures 1, 2 and 3 show the distribution of infringements observed during road vehicle inspections for each year since 2008.

It is difficult to determine a trend. Nevertheless, it is noted that the failings most frequently concern the ADR equipment, transport documents, labelling, marking and placarding.

After each inspection, if there are any infringements and depending on how serious they are, the nuclear inspector

AFCN
inspector

TABLE 1: NUMBER OF CONVEYANCES INSPECTED AND NUMBER OF INFRINGEMENTS OBSERVED

YEAR		CONVEYANCES				
		ROAD VEHICLES		TRAINS	BOATS	PLANES
		BELGIAN	FOREIGN			
2008	Total	50	12	1	2	10
	NOK*	17	3	0	0	0
2009	Total	86	20	1	1	7
	NOK	35	4	0	0	0
2010	Total	120	22	3	2	22
	NOK	21	1	0	0	0

* Not in conformity with the international/model regulations or the specifically Belgian provisions.

DISTRIBUTION OF INFRINGEMENTS/REMARKS FOR ROAD VEHICLES

FIGURE 1 : IN 2008

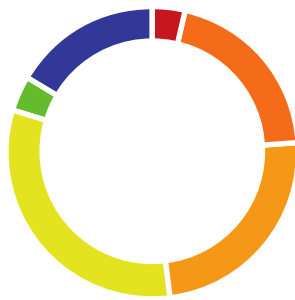

■ Stowage	4 %
■ Labelling, marking, placarding	21 %
■ Transport documents	25 %
■ ADR equipment	33 %
■ Alarm	4 %
■ Documents specific to Belgium	13 %

FIGURE 2 : IN 2009



■ Fire extinguisher	11 %
■ ADR equipment	11 %
■ Labelling, marking, placarding	14 %
■ Documents specific to Belgium	30 %
■ Transport documents	4 %
■ Packaging	2 %
■ Authorisation	2 %
■ Panels	13 %
■ Instructions	11 %
■ Loading	2 %

FIGURE 3 : IN 2010



■ ADR equipment	18 %
■ Labelling, marking, placarding	31 %
■ Documents specific to Belgium	17 %
■ Transport documents	4 %
■ Panels	9 %
■ Alarm	4 %
■ Loading	17 %

TABLE 2: FINES APPLIED IN THE RADIOACTIVE MATERIALS TRANSPORT SECTOR UNDER THE SIMPLIFIED ADMINISTRATIVE PROCEDURE

TYPES OF INFRINGEMENT

Of article 57 / On-board documents:

- transport document
- written instructions
- ADR approval document if applicable
- driver's ADR training certificate or attestation if applicable

Of article 58.4 / Particular requirements of the transport authorisation:

- copy of the transport authorisation
- warning diagram in the event of an incident or accident
- insurance certificate

Of article 57 / Equipment:

- extinguishers (fire extinguishing means)
- chock
- equipment necessary to take the general measures indicated in the written instructions (torch, fluorescent jacket, stand-alone warning signals, reflective cones or triangles or flashing orange lamps)
- equipment necessary to take additional and special measures

Of article 57 / Transport and vehicle requirements:

- label or UN number missing on packages/overpacks
- vehicle contamination
- tanker utilisation instructions

Of article 57 and/or article 58.4 / Particular requirements of the transport authorisation:

- vehicle, tank, tanker vehicle label and signalling
- co-loading with foodstuffs, medicines, chemical products and other hazardous materials
- dose rate at exterior of vehicle, driver's cab / wearing of personal dosimeter

Of article 57 / Other requirements:

- loading area locked
- engine switched off during loading/unloading
- smoking prohibition in the loading area and during handling of packages
- parking outside traffic lane
- presence in vehicle of a person not involved in the transport
- prohibition to open the packages

Of article 58.4 / Particular requirements of the transport authorisation:

- alarm on loading area gate
- requirements concerning separation from other materials

AMOUNT OF THE FINE

500 euros per specified type of infringement

125 euros per specified equipment group

500 euros per specified type of infringement

125 euros per specified type of infringement

draws up either an infringement report or a warning. Whatever the case, the offender must ensure compliance within a period set by the inspector at six months maximum, and must propose corrective and preventive measures to the AFCN to prevent similar situations arising in the future. The inspectors closely monitor the implementation and effectiveness of the measures.

Criminal sanctions, administrative fines and simplified procedures

In any legislative provision and rule of law, it is necessary to provide for sanctions. This is what the legislator did in the organic law of the AFCN by specifying that infringements of the provisions of the law or its implementation decrees shall be punished by a fine ranging from 1,000 to 1,000,000 euros, and from 3 months to 2 years of imprisonment, or by just one of these sentences.

In addition to these criminal sanctions, there is a system of administrative fines for amounts ranging from 500 to 100,000 euros. If the King's prosecutor decides not to take legal action within six months following the findings of fact, the AFCN Director-General can impose an administrative fine.

Moreover, for certain precise infringements, the AFCN nuclear inspectors can propose a simplified administrative

procedure that provides for a fine of 125 to 500 euros per infringement, with a maximum of 2,500 euros. If the offender accepts to pay through the simplified administrative procedure, any legal action or "conventional" administrative fine is automatically discharged.

Table 2 lists the infringements relative to the transport of radioactive substances for which the simplified administrative procedure can be applied, and the amount of the fine for each infringement.

Prospects

Under its preventive approach to the transport sector, the AFCN inspectors will continue the conformity audits and inspections in the field, targeting the entire transport chain, from the consignor and carrier to the consignee.

As from 2012, the annual inspection programme is going to be adapted on the basis of a progressive approach, taking into account, among other things, the types of radioactive materials transported and the number of shipments, in order to determine an appropriate audit and inspection frequency for the player concerned. ■

Interview with Eric Herman, Nuclear Inspector, Import & Transport Department – AFCN, Belgium

Contrôle : What is the AFCN's inspection policy in the radioactive material transport sector?

Éric Herman : Our policy is based more on a preventive than a repressive approach. Consequently, communication with the various players in the transport sector is much more open. This leads to a better understanding of the interests of each party (consignors, carriers, consignees, etc.), while at the same time maintaining a high level of safety, preserving our independence and ensuring our role as competent Authority.

An inspection operations plan is established each year. This plan takes into account the different types of transport, the frequencies, and the companies involved.

What means do you have to implement the policy?

Being nuclear inspector at the AFCN, I have the status of Judicial Police Officer – Auxiliary of the King's Prosecutor. I am authorised to intervene on the entire Belgian territory, and if necessary I can also call upon the law enforcement services to help me accomplish my inspections. By virtue of the regulations in force in Belgium and according to the type of radioactive materials transported, each carrier must give the AFCN either monthly transport records (at the end of each month elapsed) or transport notifications (48 hours before transport takes place). This gives me a good idea of the various movements in the different sectors of radioactive and nuclear material transport in order to target my inspections.

In practice, how do you carry out your inspections?

For road transport, the AFCN applies the Commission Directive 2004/112/EC (uniform procedures for checks). I therefore use a check-list based on that directive. All the transport-related aspects are thus checked. I also have a second check-list for the inspection aspects specific to the Belgian regulations in effect.

As for the other modes of transport (rail, air, sea), internal AFCN documents are currently being drafted so that I can have similar documents and adopt the same approach.

As for the choice of places to inspect, I focus first and foremost on the package loading and unloading sites. This means that it is often possible to inspect several vehicles or conveyances - and even different transport companies - in the same operation. In the case of special transport operations, or companies that only occasionally transport radioactive materials, insofar as possible I contact the person in charge to arrange a meeting to carry out my inspection. Some inspections are therefore announced, but others are completely unannounced. ■

The specific aspects of emergency organisation in the event of a transport accident

By Elisabeth Dupin, Inspector, Environment and Emergency Situations Department – Nuclear Safety Authority (ASN)

The transport of radioactive substances in France represents more than 900,000 packages of varied dimensions and types. The risk varies according to the content.

The ORSEC-TMR¹ plans

To prepare for the possibility of a radioactive material transport (RMT) accident in their *département*, each Prefect draws up an emergency response organisation plan (ORSEC) specific to such an event, which is called the ORSEC-TMR plan. These plans meet the inter-ministerial directive of 7 April 2005 on the action of the public authorities in the case of an event leading to a radiological emergency situation, and the circular of 23 January 2004 approving the guide to the drafting of the ORSEC-TMR plans.

Faced with the diversity of the possible types of transport operation, the ORSEC-TMR plans define the criteria and simple measures enabling the first respondents (SDIS and law enforcement services in particular) to initiate the initial reflex response measures to protect the general public, based on their findings on the site of the accident. Thus, three simple steps in the estimation of the diagnosis allow three safety perimeters to be defined:

- 1st step: 100 m exclusion zone in reflex mode (hazardous material transport accident);
- 2nd step:
 - in case of severe fire and in the presence of packages of type B, type B fissile, type C, type C fissile, or special arrangements: 100 m exclusion zone and sheltering of the population in a radius of 500 m around the accident;
 - in case of severe fire and in the presence of packages of type LSA II (tankers of uranyl nitrate) or UF₆ transport: 100 m exclusion zone and sheltering of the population in an angular sector of 60° over a distance of 1,000 m downwind of the accident;
- 3rd step: taking of the first measurements, if the dose rate exceeds 1 mSv/h over a distance exceeding 100 m, the exclusion zone is extended to 500 m.

The ORSEC-TMR plans contain useful and practical information: reflex action sheets for the various respondents, plans and maps, a description of the emergency equipment and measures, typical documents, a questionnaire to use to feed back information, sheets describing the main radioactive material packages used in France, the associated risks and the first action to be taken by the emergency services.

The national emergency organisation in the event of an RMT accident

The national emergency organisation is structured in circles of competence:

- the **circle of expertise** which gives a diagnosis and prognosis of the consequences of the accident on the radioactive material packages and the environment (Emergency Technical Centre (ETC) of the IRSN and the Emergency Technical Teams (ETT) of the consignor and carrier);
- the **decision-making circle** which develops the accident management strategies for managing the packages and environmental and health impacts. It is the Prefect (acting as Relief Operations Director) who decides on the triggering of the ORSEC-TMR plan and takes the necessary measures to ensure the protection of the population and property threatened by the accident. He is supported by the ASN's Command and Decision Post (PCD) which provides its assistance on the basis of the accident diagnosis and prognosis and its effective and potential consequences. ASN, the regulating Authority, also sends inspectors to the site and to the Prefect's office. The carrier and the consignor for their part must deploy an organisation and means for controlling the

Emergency exercise (empty drums simulating packages containing radioactive materials)



1. TMR (Transport de Matières Radioactives) is the French equivalent of RMT (Radioactive Material Transport)

sation

accident, assessing and mitigating its consequences, protecting the people around the accident site, and alerting and regularly informing the public authorities.

- the **action circle** which implements the measures necessary to control the event. This includes the fire brigade, the SAMU (emergency medical assistance service), the law enforcement services, the specialist firemen of the CMIR (mobile radiological intervention unit), and the mobile units of the IRSN, the consignor and the carrier. All these entities are under the command of the Relief Operations Coordinator, who is usually the Sub-Prefect and who applies the decisions of the Relief Operations Director;

- the **communication circuit** which informs the audiences (institutional, media, local population) on the development of the situation. All the players (Prefect's office, consignor, carrier, ASN) are required to communicate in their specific area of competence.

The MARN (Nuclear Risk Management Aid Committee) of the DSC (Civil Protection Directorate) are at the disposal of the prefects.

RMT exercises

RMT exercises are organised at least once a year. The Prefect's office coordinates the local preparation of the exercise and sets the general objectives. ASN ensures the national coordination and prepares the general file for the exercise: description of the national emergency organisation, of the objectives and characteristics of the exercise, and sheets describing the roles, objectives and evaluation criteria for



The analysis of incidents involving radioactive material transport operations

Deviations from the regulations relative to the transport of radioactive materials must be notified to ASN in accordance with the events notification guide, as required by article 7 of the TMD² order. This events notification guide was sent by letter to the various entities involved in radioactive material transport on 24 October 2005, and can be consulted on the ASN web site www.asn.fr. It defines the various conditions of notification and classification of transport events on the INES scale. Thirteen notification criteria are used to determine what constitutes a significant event in the transport of radioactive materials that must be notified.

ASN is notified of between 60 and 90 significant events relating to radioactive material transport every year. They concern varied deviations: deviations relating to labelling or placarding, exceeding contamination and radiation intensity limits, inadequate or deficient securing, falls and impacts of medical packages during their handling in airports, deviations with respect to the package utilisation and maintenance manuals, traffic accidents with no impact on the package, etc.

These events are generally rated level 0 on the INES scale.

About ten incidents rated level 1 are recorded each year. No incident relating to the transport of radioactive substances rated higher than level 1 has been notified since 2000, with the exception of a level-3 event concerning a package of radioactive materials transported by air that transited via Roissy in 2002 and led to irradiation (see following box).

Among these events, some twenty each year concern packages of radionuclides for medical uses that get damaged in the freight areas of airports or during their transfer to and loading onto the aircraft (usually excepted or type A packages).

2. Order of 29th May 2009 amended, on the land transport of dangerous goods (called the "TMD order").





The majority of these events, which are rated level 0 on the INES scale, or are below the scale, are declared because the packages have received an impact or a cardboard box has been torn (without the internal container being damaged). This type of incident is planned for in the normal and routine transport conditions (vibration, acceleration, resonance that can occur in routine transport and minor incident conditions). These packages are reconditioned before being sent into the aircraft.



These events can however have more serious consequence and lead to irradiation of persons or loss of package containment with ensuing contamination (see box below). Package losses are also notified each year (packages lost during a transfer or not taking the planned flight).

By listing and analysing the various transport incidents, ASN can identify the problems faced by the transport operators and the possible safety risks, in order to improve current practices and identify any needs for changes in the regulations. This experience feedback is also studied when defining ASN's action priorities and its inspection programme.

Thus, further to the various events occurring in airports over the last few years, ASN has initiated several actions to raise airport companies' awareness of the problem. A guide on the regulatory requirements applicable to the transport of radioactive materials in airport zones was drawn up by ASN in 2006 and posted on its web site. An information seminar was then organised for the airport companies by ASN and the DGAC (General Directorate for Civil Aviation) on 1 February 2010, on the DGAC's premises, to reiterate the requirements of the regulations and present good practices.

ASN and the DGAC carry out joint inspections in the airports each year. In 2011, for example, inspections were carried out in the airports of Roissy-Charles-de-Gaulle, Orly, Marignane and Roland-Garros (on Ile de La Réunion). These inspections too frequently revealed shortcomings in personnel training and awareness of the dangers of ionising radiation, the lack of a radiation protection programme and of management procedures for radioactive material packages (securing procedure, procedure to follow in the event of an incident or accident). ■

Reflex sheet for a type B fissile package

Colis de transport d'assemblages combustibles irradiés TN 12 ou TN 13 ou LK 100 ou TN 17	
	
Picardage du véhicule	
UN 3328 UN 3329	Etiquetage et marquage de l'emballage  
FICHE REFLEXE	
ACTIONS IMMEDIATES	
f Port d'une tenue spéciale de protection pour l'intervention f Création d'un périmètre circulaire d'exclusion de 100 mètres de rayon autour du colis. Création d'un périmètre circulaire de mise à l'abri de 500 mètres de rayon en cas d'incendie supérieur à 30 minutes et en cas de rejet de radioactivité détecté. En cas de débit de dose supérieur à 1 mSv/h à 100 m du colis évacuer une zone circulaire de 500 m de rayon autour du colis.	
ACTIONS EN CAS DE FEU	
<i>La matière est ininflammable et inexplusive</i> f Eteindre avec de la mousse, de la poudre chimique, du sable ou de l'eau (s'il y a eu dommage mécanique grave au colis, l'eau est interdite) f Refroidir avec de l'eau tout emballage ayant été exposé au feu f Si possible empêcher l'eau de s'écouler vers des points sensibles (risque de pollution) f Après extinction, veiller à ce que l'emballage puisse se refroidir naturellement (pas d'obstacle sur les ailettes de refroidissement).	

each player. The exercise scenario is prepared by the IRSN.

The exercises mobilise the emergency organisation that would be set up by the public authorities, the consignor and the carrier in the event of a radioactive material transport accident, in order to evaluate the coordination between the players, the consistency and effectiveness of the actions implemented and the intervention capacities in the field.

On the basis of a fictitious accident scenario affecting an RMT operation, and which is unknown to the participants, the exercise must lead the players concerned by safety and civil protection to:

- understand the state of the accident-stricken radioactive material shipment, predict how it will evolve and restore a satisfactory state of safety as quickly as possible;
- assess the nature and extent of the actual or potential radioactive releases, limit their quantity and determine the health impact for the population in the vicinity of the accident;
- implement the population protection measures;
- propose a package recovery plan if applicable.

Media pressure can also be simulated by having journalists present.

The exercises are organised in priority in the *départements* that do not have nuclear facilities and do not have the “nuclear culture” that naturally results from the proximity of such a facility. To give an example, in 2010 an exercise held in the Lot et Garonne *département* simulated a road accident between two heavy goods vehicles, one of which was transporting drums of uranium dioxide (UO₂) – some of which were ejected from the vehicle or even destroyed, and fire broke out. This exercise showed that little reliable information concerning the state of the packages was rapidly available from the accident site at the beginning of emergency management because the first images sent did not show this. It would be worthwhile identifying other existing imaging resources (held by the GIE Intra³ and the Gendarmerie in particular), complementary to those of the national emergency organisation, and which could improve the transmission of information.

Experience feedback and possible developments

After each exercise, ASN organises a debriefing meeting with all the players to make a general assessment of the exercise. The exercises and real-life cases enable the difficulties inherent to this type of accident to be identified, and lines for improvement to emerge:

– it is not always easy to rapidly determine the risks associated with a transport load: the placards identifying the load

may be illegible in case of fire, and the documentation destroyed. It may be long and complicated to move back up the line to the carrier and the consignor to obtain the information essential for management of the accident;

– unlike the populations who live within the alert perimeter of nuclear facilities, the populations and media around the site of the accident have generally not been made aware of the nuclear risk and do not know the principles of sheltering and listening for instructions. There are no alerting systems either. Straight forward evacuation seems the most appropriate solution given the small number of people affected;

– it can take a long time to get the appropriate expertise to the accident site, and people are sometimes obliged to take the first decisions “blindly” during the first hours following the accident.

To take these lessons into account, the public authorities are going to undertake a reflection on the management of RMT accidents that should result in concrete and practical proposals for improvements in the reflex phase (at the beginning of the RMT accident) as well as in the training and exercises. ■

3. GIE Intra: A joint organisation between CEA, AREVA and EDF, which has means for intervening in contaminated areas (robots).

Events associated with the air transport of radioactive materials: some notable findings

– **On 17 August 2002** at Roissy CDG airport, a type A package containing capsules of iodine 131 used in nuclear medicine fell from the truck that was transporting it to the aircraft. It was crushed by vehicles on a service road linking two of the airport terminals. This resulted in a loss of containment and the dispersion of radioactive material on the road. The road surface and hard shoulders were contaminated. The medical examinations of the intervening personnel revealed very slight contamination, with no consequences on their health. The event was rated level 1 on the INES scale.

The reactive inspection that followed the event revealed that the packages are rarely secured during their transport on the airport, and that the personnel is not sufficiently aware of the dangers of ionising radiation and the precautions to take during handling and in the event of an incident or accident.

– **In January 2002**, a level 3 incident was notified by a Swedish consignor. A type B package containing iridium 192 pellets shipped by air from Sweden to the USA and in

transit at Roissy CDG airport, displayed an abnormally high dose rate: 4 mSv/h at a distance of 25 metres (instead of the authorised 2 mSv/h in contact with the package).

When the package was opened, a packaging error was discovered: the lids of two of the three cases were unscrewed; numerous pellets had escaped from the horizontally positioned cases during transport and had spread into the gap around the lid and the package.

An American driver received a dose of 3.4 mSv in 10 minutes. Medical analyses also revealed that two employees of the air carrier at Roissy probably received doses of about 30 mSv and 100 mSv during package transit.

ASN carried out a reactive inspection on the premises of the carrier Federal Express (Fed Ex) at Roissy, and reiterated the fact that since 1 July 2001, operations relating to air transport of radioactive materials must be governed by a radiological protection programme (§ 1-1.3.2 of the technical instructions of the ICAO). ■

Very short-lived radionuclides in medicine: the transport challenge

By Guy Turquet de Beauregard, Executive Vice-President - IBA Molecular Europe, Saclay

Nuclear medicine is based on the use of the radiation emitted by a radioactive atom introduced into a biomolecule with the aim of diagnosing by gamma-ray imaging, heart, oncological, neurological, or thyroid diseases, or, more rarely, treating a disease by internal radiotherapy (by α or β radiation).

Medicine is now evolving towards personalised care for each patient, and nuclear medicine is growing rapidly in all its life science applications. This can in fact be explained by the concomitance of four factors:

- the power of the computation microprocessors of the γ -ray cameras can now produce complex tomographic images of the patients in just a few minutes;
- the unique contribution of hybrid γ -ray cameras (i.e. PET scan) gives the clinicians, in a single examination, an image of a patient's pathologies that is both morphological (by the X-ray scanner) and functional (by the γ -ray camera) [see figure 1];
- the significant reduction in the price of γ -ray cameras and cyclotrons makes these examinations accessible to a very wide public;
- lastly, the explosion of knowledge in molecular and cellular biology offers a considerable potential of vectors (ligands) specific to a disease, which can be used for radioactive labelling for diagnostic imaging of patients.

The use of radiopharmaceuticals, which are nuclides injected into patients for examinations that lasts several tens of minutes, obliges the use of radionuclides with very short half-lives in order to limit the dosimetry of the patient and the medical personnel.

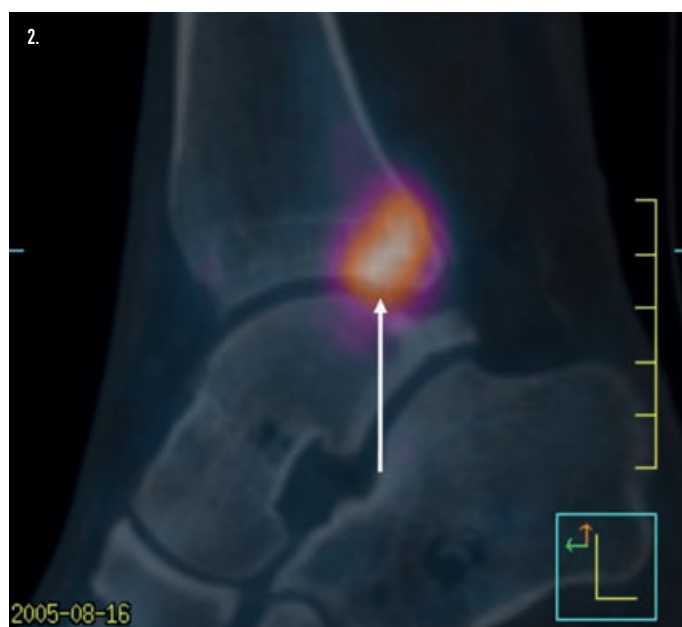
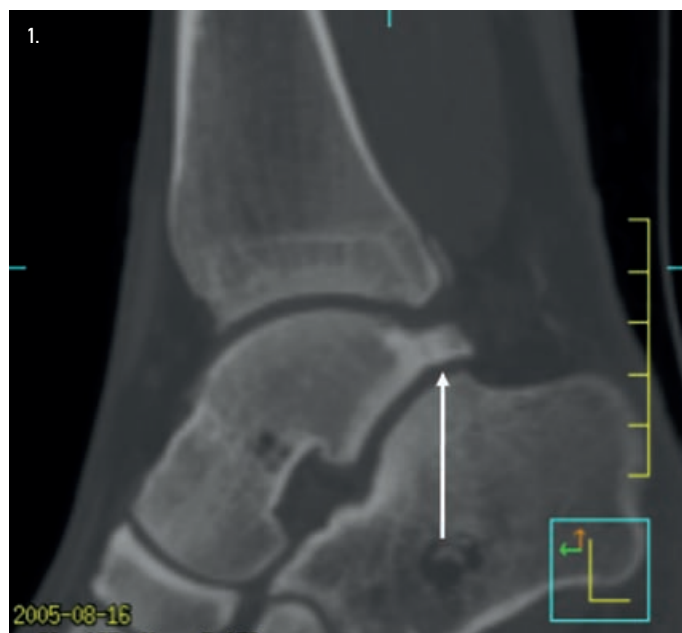

This radioactive decay (half-life ranging from a few hours to a few days) has two major consequences: firstly the dose rates of the packages are at their maximum during shipment, therefore there is a high ALARA (As Low As Reasonably Achievable) implication, and secondly, the medical value of the radiopharmaceutical decreases rapidly, therefore logistics becomes a key factor in the success of this discipline.

The challenge for the transport of very short-lived radioactive products starts in practice with the production of the radionuclides themselves, and ends with the distribution of the radiopharmaceutical drugs in the healthcare or research centres.

At this stage it is important to focus on the main challenges specific to the transport of radionuclides for use in nuclear medicine:

- the transport across Europe of highly enriched uranium targets after irradiation in reactors;
- the pre-shipment inspection of thousands of packages every day;

- ensuring the traceability of the packages until they reach the destination nuclear medicine service;
- the dosimetry of the shipping and transport personnel;
- the management of emergency situations.

The transport of highly enriched uranium targets after irradiation in reactors

The radionuclides used in medicine are essentially produced by either of two methods: using protons produced by cyclotrons - a method that is currently growing strongly - destined for PET (Positron Emission Tomography) scanners, or neutron irradiation in reactors to generate fission products such as Mo/Tc99.

As regards the latter fission product, Technetium Tc99m (half-life of 66 hours) coupled with a biological vector is used in nearly ¾ of the diagnostic examinations in nuclear medicine (more than 30 million per year worldwide). The problem is that the unplanned shutdown of two of the five reactors in the world used routinely to produce this radionuclide led to a shortage in supply. The solution consisted in using new reactors and having greater collaboration between competing producers. But this situation revealed a serious lack of compatibility between the uranium packages used by the different producers. It also necessitated new authorisations for the transport of irradiated uranium targets for some countries that had to be crossed.

The European Council of Ministers asked the European Commission to ensure a good level of coordination in these questions, while satisfying both nuclear safety and EC competition requirements.

The inspection of radiopharmaceutical packages and their traceability until they reach the destination nuclear medicine service

Millions of radioactive drugs are shipped each year, with activities ranging from a few tens of MegaBecquerels (MBq) to several hundred GigaBecquerels (GBq) (see figure 2).

Transported by air and road, these radiopharmaceutical packages must comply with all the French and international regulations governing nuclear safety, radiation protection, the health code and, since 11 September 2001, protection against malicious acts and terrorism.

The pivotal point of this logistic chain is in fact the appointment with the patient, which triggers the manufacture and shipment of the radiopharmaceutical.

As regards the transport of radioactive medication, the critical daily steps are:

- procurement of the raw materials, which may come from the other side of the Atlantic;
- “just-in-time” production, in accordance with good radiopharmaceutical practices;

- preparation of the documents, labelling of the finished products, and their pre-departure inspection;
- organisation of operations with the forwarding agents and airlines;
- safety files for the transport containers demonstrating radiation protection and integrity in accident situations;
- ensuring the traceability of the transport stages to rapidly identify any malfunction, from the consignor through to the destination nuclear medicine service;
- informing and training the various people involved, airport personnel included.

This complex organisation is nevertheless facilitated by the highly repetitive logistics. In practice, the production and shipping cycle is identical each week. This makes it possible to plan all the transport logistics in advance.

The standardisation of radiopharmaceutical packages has allowed the implementation of a computerised system for calculating the transport indices, which are moreover validated by a measurement taken systematically at the exit from the production line.

Shipping personnel dosimetry and the conflicting regulations

As was mentioned at the beginning of the article, the dose rates of radiopharmaceutical packages are inherently maximal at the moment of production and decrease thereafter until the drug is injected into the patient, so it is forcibly during transport that the dose rates are highest. Among nuclear workers it is therefore the operators involved in the shipping and transport of radiopharmaceuticals who have the most significant dosimetry levels. The challenge is therefore to render compatible two objectives that are contradictory for operator dosimetry, namely to firstly ensure full traceability of the package by applying or checking regulatory labels for pharmaceutical and radioactivity reasons, in addition to measuring the dose rate in contact with the packages before shipment, while secondly complying with the ALARA principle for these same operators.

In this context it is essential to use all modern means available (robots, bar codes, active labels, etc.) to limit the dosimetry. It is just as essential that the nuclear and pharmaceutical regulations adapt to the specifics of nuclear medicine by limiting package labelling to the strict necessary in order to reduce the need for operator presence near the irradiating packages.

Management of transport events and incidents

Experience has shown the importance of having prepared an emergency plan to respond to transport incidents.

It consists in setting up an emergency unit manned by persons, each of whom has a precise duty, supported by the necessary

documents - particularly a reflex sheet - and appropriate means of communication. This is the case today.

Each year, between ten and twenty type A or excepted packages in France get damaged, but to a very limited extent, and cases of contamination are very rare.

Almost all the damage occurs at airports, during handling in the depot or when being transported to or loaded onto the aircraft.

The overall event rate is less than one package in 10,000 shipped.

It has been agreed with ASN that any event - no matter how minor - occurring in France and concerning any of the various stages of radioactive transport, should be reported.

It is clear that this practice, which is understood by the licensees who are accustomed to the "early warning signs" culture of nuclear safety, is poorly understood and accepted by the various entities involved at the airports. It is therefore important for ASN and the DGAC (French General Directorate of Civil Aviation) to fulfil their role as regulator, because no consignor can be the "regulator", even if the regulations implicitly ask them to do so.

Here we are touching on a critical point of nuclear medicine.

Our economic weight is tiny compared with the media risks or the expenses created by this type of shipment.

It is therefore essential, as a minimum, that airport responsibilities as defined by the public authorities should include providing a structure capable of dealing with packages of this type. This is typical of a requirement that only a public service can fulfil.

The pressing need for European coordination

All the players of the nuclear medicine industry in Europe are grouped together within the AIPES (Association of Imaging Producers and Equipment Suppliers) in Brussels. The AIPES aims at harmonising the safety and security rules so that they are not used as "economic" selection criteria. To have equitable competition in a competitive sector in Europe, it is essential to subject all the players to the same regulations.

It can be seen that although nuclear medicine has become a pillar of personalised medicine, it has to operate in a very cumbersome regulatory environment which must remain appropriate for the real risks of the discipline. ■

The role of the small-scale nuclear activities transport safety advisor

Interview with Jean-Marie Eymat, Transport Safety Advisor - Sécuritrans

Contrôle : Mr Eymat, you are an external transport safety advisor (TSA) for ISOLIFE and ISOVITAL, two radiopharmaceutical product carriers. Could you briefly explain your duties to us?

Jean-Marie Eymat : the duties of the TSA correspond to "tasks" such as they are defined in section 1.8.3.3. of the ADR regulations.

The identification/classification of the radiopharmaceuticals is verified by sampling inspection. Driver and vehicle inspections are undertaken, and advice can be given on the purchase of conveyances. Certain procedures and other security-related instructions are regularly applied. I also attentively monitor subcontracting. I send the inspection reports and the annual report to company senior management.

If necessary, accidents, incidents and serious infringements are analysed, a report is drawn up and measures are implemented.

I also keep track of the regulatory training courses: training/awareness raising sessions are organised, with a considerable part devoted to "radiation protection". From time to time we participate in audits of consignor customers.

How much time do you devote to these two companies?

I spend one to two days every two months on the ISOLIFE site (radiation protection included). The visits to ISOVITAL are scheduled two times per year. For each transport Commissioner, the personnel training/awareness sessions can represent three to five days per year. The visits by the transport plan "relaying" personnel and the vehicle/driver inspections are spread over the year and grouped by geographical sector. I do a lot of work over the telephone, particularly for dosimetry monitoring.

As a general rule, how do you perceive the changes in radioactive material transport regulations over the years? How do you organise your regulations watch?

At the end of the 1980's I saw the very beginning of the transport of radiopharmaceutical packages by road; the ADR agreement was hardly recognised. At that time,



Radiopharmaceutical packages secured in a transport vehicle

awareness of the regulations and safety such as they are anchored in the culture of the players today, did not exist. In 2000, the main change was the appointment of TSAs in the companies.

Road transport inspections were targeted and ASN increased its inspections, favouring application of the ADR regulations.

The “restructured” ADR also improved the reading and application of the regulations.

Today we observe that on the whole, the road transport of radiopharmaceutical packages complies with the ADR regulations.

The regulatory watch is carried out by registering the information provided by the “official bodies” and other web sites, and after making selections specific to the activities, the information is communicated to the companies, possibly accompanied by a follow-up service.

Through your profession as an advisor, you are a source of proposals and recommendations. Are they often followed? Have you set up an audit system?

Making proposals and recommendations remains the underpinning basis of the TSA’s mission. We find company managers who are attentive and determined to apply them, especially when the radiation protection of the personnel is at stake.

I conduct audits and any deviations observed are noted in a “record of actions” and submitted to the company managers for remedial action. If necessary, we validate implementation times and implementation at meetings, then we close the actions.

You are also a qualified PCR (Person Competent in Radiation protection). As such, you have an enlightened view on questions of radiation protection. What do you think of radiation protection in the transport of radiopharmaceuticals?

I think that radiation protection is a necessity in the transport of regulated radiopharmaceutical packages. Driving times are sometimes long, in which case driver radiation exposure is significant. The moment this type of shipment is involved, the ALARA principle must be applied and a PCR must monitor the shipment.

For these regulated shipments, I see the function of TSA as being combined with that of PCR, as the two roles are complementary and very closely interleaved.

What do you think of the ASN’s oversight role, particularly through its inspections?

The ASN inspections consolidate the position of the TSAs within companies.

During inspections and when reading the annual reports, the inspectors verify the implementation of the proposals made to improve safety, they promote the application of recommendations and implementation of actions.

The inspectors sometimes provide information or confirmations for the TSA.

Nevertheless, for the transport companies that apply the regulations to the letter, it would be nice to see “inspection follow-up letters” that are totally devoid of “remarks” or even “observations”. ■

Experience feedback from inspections and raising awareness among the small-scale nuclear activity players

Interview with Jean-Christophe Luc, Radiation Protection and Radioactive Material Transport Inspector, Bordeaux Division of ASN

Contrôle : The majority of uses of ionising radiation involve the transport of radioactive materials, whether for radiopharmaceutical products for medical uses or spent fuels from nuclear power plants.

What do small-scale nuclear activities account for in radioactive material transport in South-West France?

Jean-Christophe Luc : the estimated number of packages containing radioactive materials transported by road in South-West France exceeds 150,000 per year. Less than 600 of them concern the three nuclear power plants. The radioactive materials transported in the small-scale nuclear activities are either devices containing sealed radioactive sources used on work sites (gamma ray projectors, gamma ray densitometers, devices for detecting lead in paint, borehole logging devices), or unsealed radioactive sources used in nuclear medicine departments for diagnostic or therapeutic purposes, or in research laboratories. Some 100,000 devices for detecting lead in paint and 30,000 medical packages are transported each year. In terms of transported activity on the other hand, the order of importance is reversed. The spent fuel packages from EDF sites contain very high activity and present very high radiation protection and nuclear safety implications. Conversely, the majority of packages from small-scale nuclear activities contain an activity ranging from a few MBq (MegaBecquerels) to a few tens of GBq (GigaBecquerels), apart from the gamma ray projectors whose sources attain a few TBq (TeraBecquerels). The radiation protection and nuclear safety risk implications in small-scale nuclear activities nevertheless remain real, due above all to the number of packages transported.

What types of transport players do you meet? Do you tend to meet small companies or large groups?

The transport of radioactive substances concerns the package designers and manufacturers, the package consignors, the forwarding agents (companies that organise the transport for consignors), the carriers (who transport the package) and the package consignees.

In the field we essentially meet consignors (EDF power plants, radiopharmaceutical production laboratories), carriers and consignees (nuclear medicine departments, research laboratories). As for the carriers, two categories must be identified: the users of sealed sources who travel to their work sites, and the

companies who transport packages for third parties. The consignors - producers of radioactive materials - are large sized companies belonging to groups with several production sites. The carriers on the other hand are small companies employing just a few drivers, usually less than ten. The consignees - users of the radioactive sources - are usually of an intermediate size.

The transport activity is related to your main activity as radiation protection inspector, particularly in the field of industrial radiography. Nevertheless, how much time do you think you devote to the transport activity?

Being both a radiation protection inspector and a radioactive material transport inspector is an undeniable asset that gives me an integrated view of the two areas. I can quite readily broach the subject of transport during a radiation protection inspection and vice versa, particularly in the area of gamma radiography. As the division's transport coordinator, I am the chief point of contact for my colleagues from the division, for the DTS and for the licensees. I participate in more than half the transport inspections carried out locally and investigate some of the significant events notified to us.

As a first approximation, I would say I devote 10% of my time to the inspection of radioactive material transport. This is a small proportion given the implications and volume that the transported packages represent. In truth, it seems to me that transport oversight, such as it is currently scaled by ASN, is insufficient, particularly in the small-scale nuclear activities.

How have ASN inspections in this area evolved since the TSN act was introduced?

When I arrived at the Bordeaux division in 2005, only the nuclear power plants were subject to an annual inspection. The small-scale nuclear activities, which were little known at the time, were not subject to transport inspections. Since then, the inspections performed by the division have increased with the improvement in knowledge of the locally established activities concerned. From 2006 to 2009, we intensified our inspections on the transport of radiopharmaceutical products, for which we did not know the volumes involved.

Although the TSN act has unquestionably given a

Transport of a gamma ray densitometer



sound legal basis to the inspection of radioactive material transport, it has not significantly changed inspection practices in the field.

What are the main findings drawn from the inspections?

It should firstly be noted that no serious incident or accident relating to the transport of radioactive materials, calling into question safety or radiation protection, has occurred in South-West France.

The various players concerned know the regulatory baseline and meet its essential requirements. They are assisted by the transport safety advisor whom they designate, they have a radiation protection optimisation approach, ensure that the package and the vehicle bear the correct labels and markings, and organise worker radiation protection.

On the other hand, they must be more rigorous in the verification of shipment conformity and ensure the traceability of that verification. The conformity of packages that are not subject to approval is not demonstrated. Particular attention must be paid to the conditions of bracing and securing of the packages in the vehicles. The radiological inspections are sometimes deficient. Lastly, often the small entities have not defined a specific organisational structure for managing emergency situations.

Transport is sometimes not the main activity of a company. In such cases, do you make more findings?

The dividing line is not determined solely by the primary or secondary nature of the transport activity, but also by how far back the ASN inspections of these companies date. Thus, nuclear power plants, which have been inspected by ASN for many years, like gamma radiography companies, which have also been subject to ASN authorisation to possess and use their devices for a very long time now, are on the whole more respectful of the regulatory requirements.

The size of the company is also an important factor. Large companies that benefit from a "group" effect, are more scaled to meet the regulatory requirements. On the other hand, the transport companies whose core activity is the carriage of hazardous materials displayed – at least in the first ASN inspections - numerous deviations from the regulations.

Do you see improvements from one year to the next?

Through our inspections in the field we have seen a distinct improvement in the conditions of transport of radioactive materials since 2005. The deviations recorded are of the same nature but fewer in number. This development is particularly significant in the new areas inspected by ASN, namely the transport of radiopharmaceutical products and gamma ray projectors. I nevertheless consider that the conformity of transport operations can and must be further improved.

What measures have been taken to inform/remind the small-scale nuclear activity players? What means have been used?

As early as 2005 I felt the need to enhance our knowledge of the transport of radioactive materials in South-West France and consolidate this in a monograph. Thus, in 2007, I proposed targeting and intensifying the inspections in small-scale nuclear activities. I also contacted certain transport players, particularly the forwarding agents who work with the carriers, of whom we had little knowledge. I sent the consignees - the ASN-authorized users of radioactive sources - a questionnaire intended essentially to enrich our data and help understand the organisation of the transport operations. The findings from our inspections and this survey resulted, in 2009, in the writing of a monograph that gives readers an overall and detailed picture of the transport of radioactive materials in South-West France. Two years later, this monograph remains a reference work basis for the division.

We use this analysis in our inspections to remind the players of the regulatory requirements and the expectations of ASN in this area. The division is considering bringing together the local transport professionals in a thematic workshop to firstly present ASN's findings in the field, and secondly encourage discussions and feedback from the professionals.

What other means do you have to make them sensitive to compliance with the radioactive material transport regulations?

Making the transport professionals sensitive to compliance with the regulations requires on the one hand assisting, teaching, explaining, and on the other, measures of coercion or punishment for the most serious infringements.

The ASN's teaching efforts are made constantly during its inspections, in its answers to questions and in the issuance of circular letters. The professional seminars also present a definite interest. Locally we could also send information mailings. At national level ASN could draw

up other guides for the professionals, popularisation aids for regulations, which are sometimes complex.

Over and beyond the teaching efforts, ASN is a regulating authority whose prime role is to ensure compliance with the regulations. It is therefore justified, when a situation so requires, to use the means of coercion and sanction provided for by law. I consider that these means would merit being put to greater use by ASN in the field of transport, on the same account as its accompanying actions. ■

CONTRÔLE the French Nuclear Safety Authority review

6, place du Colonel Bourgoïn, 75572 Paris Cedex 12 - France
Broadcasting: Phone: 33 (0)1.40.19.86.53 – Fax: 33 (0)1.40.19.86.32
E-mail: info@asn.fr

Publishing director:

André-Claude LACOSTE,
Chairman

Deputy publishing director: Alain DELMESTRE

Coordinator: Laurent KUENY

Editor: Marie-Christine BARDET

Editorial staff: Fabienne COVARD

Contributor to this issue:

Pascale LUCHEZ

Cover :

Realization : ARTYG / photo : Iris Graffunder

P. 1 : ASN/V. Bourdon, p. 4-5 : Laurent Mignaux/MEDDTL,
p. 6 : Cegelec, p. 9 : ASN/ V. Bourdon, p. 10 : ASN,
p. 11 : S. Whittingham, p. 12 : ASN/ P. Beuf,
p. 13 : AREVA/CAPA Entreprises, p. 15 : ASN,
p. 17 : ASN/ N. Robin, p. 18 : AREVA, p. 19 : ASN/N. Robin,
p. 21 : AIEA, p. 23 : AIEA, p. 28 : ANDRA, p. 28-29 : ASN,
p. 30 ASN/P. Beuf, p. 31. AREVA/CAPA Entreprises,
p. 32 : Interlinks/M. Roussel, p. 34 : ASN/ P. Beuf,
p. 38 : ASN/P. Beuf, p. 40-41 : ASN, p. 42 : AREVA,
p. 43 : ASN, p. 46 : IRSN, p. 47 : ASN, p. 48 : IRSN, p. 49 : ASN, p. 50 : ASN, p. 52 : CEA, p. 53 : ASN, p. 54-55 : ASN,
p. 56-57 : Robatel, p. 61 : AREVA, p. 63 : AFCN,
p. 66-67 : IRSN, p. 70 : Lenox Hill Hospital/Philips,
p. 73 : ISOVITAL p. 75 : ASN

ISSN : 1254-8146 – Equality Committee: 1294 AD

Realization : ARTYG, Paris 2^e – Printing-Office : FABREGUE, 87500 Saint-Yrieix-la-Perche, France

Contrôle review's articles present the ASN view of the subject covered and gives an opportunity for the various stakeholders concerned to express themselves freely with regard to the law.

ASN organisation chart

at december 31, 2011

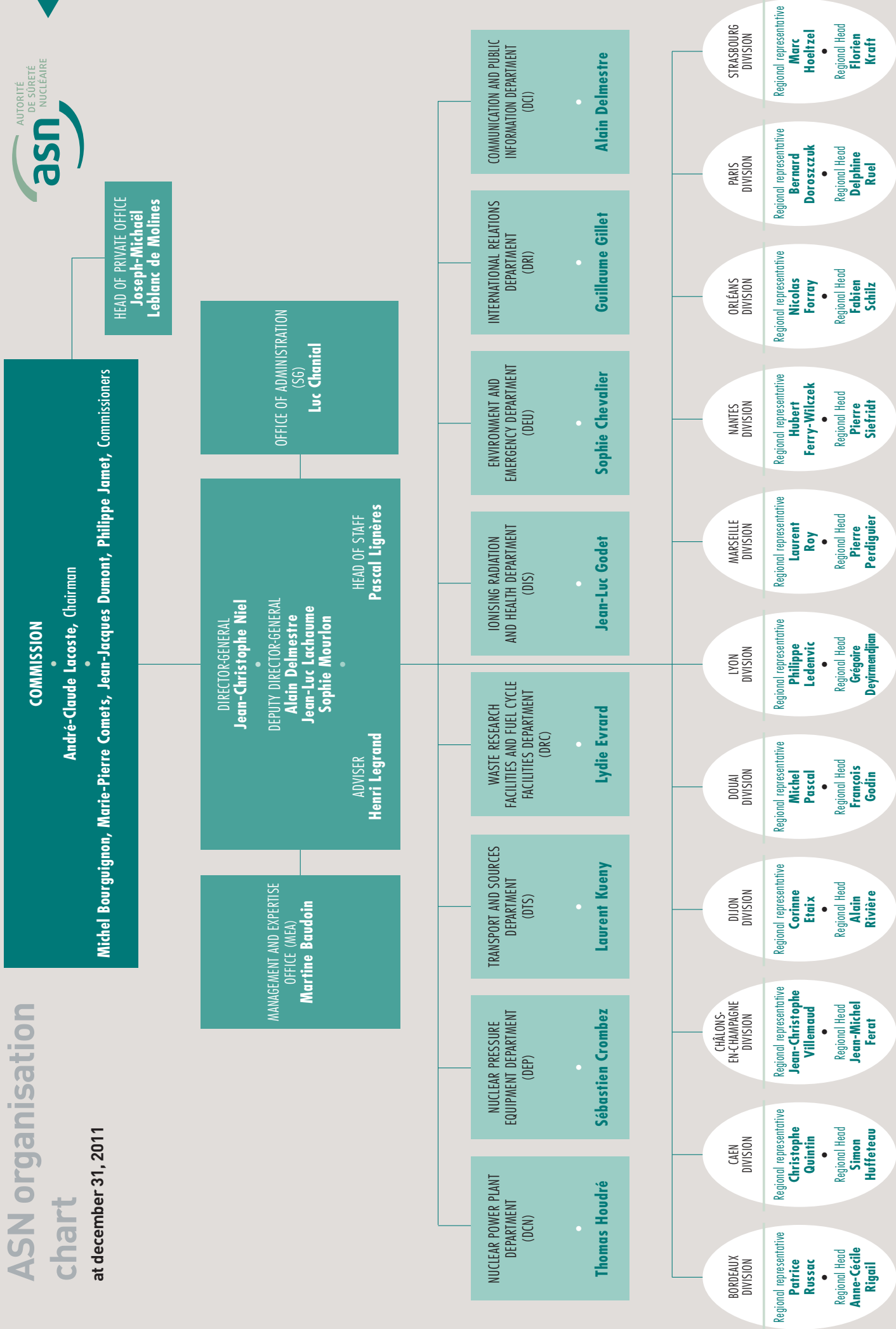

Name First Name
 Address
 Zip Code Town Country

Send to: ASN – Centre d'information et de documentation du public
6, place du Colonel Bourgoïn, 75572 Paris Cedex 12 – France – Fax: 33 (0)1 40 19 86 92

Les dossiers de la revue CONTROLE		Nbre d'ex. ⁽¹⁾	Nbre d'ex. ⁽¹⁾		
105	La sûreté des réacteurs du futur, le projet EPR (06.1995)		159	L'harmonisation de la sûreté nucléaire en Europe (07.2004)	
106	L'organisation du contrôle de la sûreté et de la radioprotection (08.1995)		160	La recherche en sûreté nucléaire et en radioprotection (09.2004)	
107	Les réacteurs en construction – le palier N4 (10.1995)		161	Contamination radioactive : quelles actions pour les sites pollués ? (11.2004)	
108	La crise nucléaire (12.1995)*	épuisé	162	La sûreté du cycle du combustible (01.2005)	
109	L'activité en 1995 de la DSIN (02.1996)*	épuisé	163	Rapport de l'ASN sur la sûreté nucléaire et la radioprotection en France en 2004 : extraits (03.2005)	
110	Le retour d'expérience des accidents nucléaires (04.1996)		164	Le réacteur EPR (05.2005)	
111	Les rejets des installations nucléaires (06.1996)*	épuisé	165	La gestion des déchets radioactifs en France (07.2005)	
112	Les exercices de crise (08.1996)*	épuisé	166	Contrôler la sûreté nucléaire et la radioprotection (09.2005)	
113	Déchets radioactifs : les laboratoires souterrains de recherche (10.1996)		167	La radioprotection internationale : les acteurs internationaux (12.2005)	
114	La communication sur les incidents nucléaires (12.1996)		168	Le risque (02.2006)	
115	L'activité de la DSIN en 1996 (02.1997)		169	Rapport de l'ASN sur la sûreté nucléaire et la radioprotection en France en 2005 : extraits (03.2006)	
116	La sûreté du cycle du combustible 1 ^{re} partie (04.1997)*	épuisé	170	La radioprotection internationale : les Autorités nationales de radioprotection (05.2006)	
117	La sûreté du cycle du combustible 2 ^e partie (06.1997)*	épuisé	171	Protéger la population en situation d'urgence (07.2006)	
118	La gestion des déchets très faiblement radioactifs (08.1997)		172	La radioprotection des patients : pour une meilleure prise en compte de la radioprotection des patients dans les pratiques médicales (09.2006)	
119	Le démantèlement des installations nucléaires (10.1997)		173	L'utilisation de sources radioactives dans l'industrie et la recherche (12.2006)	
120	Le transport des matières radioactives (12.1997)		174	La sûreté des transports des matières radioactives (02.2007)	
121	L'activité de la DSIN en 1997 (02.1998)		175	Rapport de l'ASN sur la sûreté nucléaire et la radioprotection en France en 2006 : extraits (04.2007)	épuisé
122	Le contrôle de la construction des chaudières nucléaires (04.1998)		176	Les réacteurs expérimentaux et leur contrôle (07.2007)	
123	Radioprotection et INB (06.1998)		177	Les rejets radioactifs en France (11.2007)	
124	Les relations internationales bilatérales (08.1998)		178	Les relations entre l'ASN et les différents acteurs, un an après la loi TSN (01.2008) version sur www.asn.fr	
125	25 ans de contrôle de la sûreté nucléaire (11.1998) épuisé		179	Rapport de l'ASN sur l'état de la sûreté nucléaire et de la radioprotection en France en 2007 : extraits (04.2008)	épuisé
126	La gestion des matières radioactives et son contrôle (12.1998)		180	La gestion post-accidentelle d'un accident nucléaire (07.2008)	
127	La sûreté nucléaire en 1998 (03.1999)		181	Le démantèlement des installations nucléaires de base (11.2008)	
128	Les réacteurs expérimentaux et de recherche (04.1999)		182	Contrôle du nucléaire : l'inspection par l'ASN (02.2009)	
129	Le vieillissement des installations nucléaires (06.1999)		183	Rapport de l'ASN sur l'état de la sûreté nucléaire et de la radioprotection en France en 2008 : extraits (04.2009)	
130	Sites contaminés et déchets anciens (08.1999)*	épuisé	184	La poursuite d'exploitation des centrales nucléaires (07.2009)	
131	Les systèmes informatiques dans l'industrie nucléaire (10.1999)		185	La sécurité des traitements en radiothérapie externe (12.2009)	
132	Le retour d'expérience des exercices de crise nucléaire (01.2000)		186	Le contrôle des équipements sous pression des réacteurs nucléaires (02.2010)	
133	La sûreté nucléaire en 1999 (03.2000)		187	Extraits du Rapport de l'ASN sur l'état de la sûreté nucléaire et de la radioprotection en France en 2009 (04.2010)	
134	La gestion des déchets radioactifs : l'état des recherches début 2000 (04.2000)		188	La surveillance de la radioactivité de l'environnement (06.2010)	
135	Les relations internationales multilatérales (06.2000)		189	La construction d'un pôle européen de la sûreté nucléaire et de la radioprotection (11.2010)	
136	Le risque d'incendie dans les installations nucléaires (09.2000)		190	La gestion des déchets radioactifs : avancées et perspectives (02.2011)	
137	Les rejets des installations nucléaires (11.2000)		191	Extraits du Rapport de l'ASN sur l'état de la sûreté nucléaire et de la radioprotection en France en 2010 (04.2011)	
138	Le plutonium (01.2001)		192	Imagerie médicale : maîtriser les expositions aux rayonnements ionisants (07.2011)	
139	Rapport sur la sûreté nucléaire en France en 2000 (03.2001)		193	La sûreté des transports de substances radioactives (03.2012)	
140	L'homme, les organisations et la sûreté (05.2001)		194	Extraits du Rapport de l'ASN sur l'état de la sûreté nucléaire et de la radioprotection en France en 2011 (06.2012)	
141	Sûreté nucléaire et transparence (07.2001)				
142	La protection contre les risques externes (09.2001)	épuisé			
143	Le contrôle de l'utilisation des rayonnements ionisants (11.2001)				
144	L'inspection des installations nucléaires (01.2002)				
145	Rapport sur la sûreté nucléaire en France en 2001 (03.2002)				
146	Transport des matières radioactives (05.2002)				
147	Les réexamens de la sûreté des installations nucléaires (07.2002)				
148	La radioprotection des patients (10.2002)	épuisé			
149	La surveillance radiologique de l'environnement (11.2002)	épuisé			
150	Sûreté et compétitivité (01.2003)				
151	La sûreté nucléaire et la radioprotection en France en 2002 (03.2003)				
152	Le démantèlement des installations nucléaires : le nouveau panorama (05.2003)	épuisé			
153	Le radon : évaluation et gestion du risque (06.2003)				
154	Les enjeux de la maintenance (09.2003)				
155	Les études probabilistes de sûreté (11.2003)				
156	Épidémiologie et rayonnements ionisants (01.2004)				
157	Rapport de l'ASN sur la sûreté nucléaire et la radioprotection en France en 2003 : extraits (03.2004)				
158	La radioprotection des travailleurs (05.2004)				

(1) Maximum 5 issues

* The out of stock issues can be consulted at ASN's Information and Documentation Center (Paris, France)

also available in english

BULLETIN D'ABONNEMENT A LA REVUE *CONTRÔLE*. "CONTRÔLE" NEWS MAGAZINE SUBSCRIPTION VOUCHER

Civilité / Title: Nom / Surname: Prénom / First Name:

Organisme ou entreprise / Company:

Adresse à laquelle vous souhaitez recevoir *Contrôle* / Address:

Code postal / Post code: Ville / Town: Pays / Country:

Abonnement à titre / Subscription type: professionnel / *professional*
 personnel / *personal*

• 1^{er} abonnement / 1st subscription:

• Modification / Modification

N° d'abonné / Subscription number:

Civilité / Title: Nom / Surname: Prénom / First Name:

Organisme ou entreprise / Company:

Adresse à laquelle vous souhaitez recevoir *Contrôle* / Address:

Code postal / Post code: Ville / Town: Pays / Country:

• Suppression / Cancellation

N° d'abonné / Subscription number:

Motif / Reason:

Renseignements complémentaires / Other information:

Secteur d'activité / Sector:

- | | |
|---|---|
| <input type="checkbox"/> Administration / <i>Civil Service</i> | <input type="checkbox"/> Communication, médias, publicité /
<i>Communication, media, advertising</i> |
| <input type="checkbox"/> Collectivités locales / <i>Local authorities</i> | <input type="checkbox"/> Enseignement, Formation / <i>Education</i> |
| <input type="checkbox"/> Industrie nucléaire / <i>Nuclear industry</i> | <input type="checkbox"/> Secteur médical / <i>Health</i> |
| <input type="checkbox"/> Autres industries / <i>Other industries</i> | <input type="checkbox"/> Syndicats et ordres professionnels / <i>Trade unions</i> |
| <input type="checkbox"/> Associations et sociétés savantes / <i>Associations,
learned societies</i> | <input type="checkbox"/> Particuliers / <i>Individuals</i> |
| <input type="checkbox"/> Bureau d'étude, conseil, ingénierie / <i>Engineering,
consultancy</i> | <input type="checkbox"/> Autre, précisez / <i>Other, please specify:</i>
..... |

Catégorie / Category:

- | | |
|---|--|
| Consultant / <i>Consultant</i> | Journaliste / <i>Journalist</i> |
| Experts, appuis techniques / <i>Experts, technical advisors</i> | Juriste / <i>Law</i> |
| Exploitant d'une installation nucléaire / <i>Nuclear operator</i> | Précisez / Specify: |
| Détenteur de source radioactive / <i>Owner of radioactive sources</i> | Militaire / <i>Military</i> |
| Industriel / <i>Manufacturer</i> | Membre d'une Autorité de sûreté nucléaire / <i>Member of a
nuclear safety authority</i> |
| Profession médicale / <i>Medical speciality</i> | Précisez / Specify: |
| Précisez / Specify: | Membre d'une organisation internationale /
<i>Member of an international organisation</i> |
| Documentaliste / <i>Documentalist</i> | Diplomate / <i>Diplomat</i> |
| Enseignant / <i>Teacher</i> | Retraité / <i>Retired</i> |
| Etudiant / <i>Student</i> | Autre / <i>Other,</i> |
| Formateur / <i>Trainer</i> | Précisez / Specify: |
| Chercheur / <i>Researcher</i> | |
| Elus / <i>Local government</i> | |

Nous vous remercions de retourner ce bulletin complété à l'adresse suivante / *Please return this voucher once completed to:*

INTER ROUTAGE / Service Informatique – 49-55, rue des Écoles – 93321 Aubervilliers Cedex

Information in real time
on behalf of the State
in the service of its citizens

www.asn.fr



News about nuclear safety and radiation protection, the activities of the French Nuclear Safety Authority (ASN) as regards industry and operators, the reports of the Magazine *Contrôle*, follow-up letters after inspections, local action, practical information and comprehensive archives. Find out all you want to know about the Authority of Nuclear Safety and what it does - permanently at your service on the web.



Improving nuclear safety
and radiation protection

